

# 10 Trolleys

Carros  
Chariots



## 10.1 SERVING TROLLEYS

288

CARROS DE SERVICIO  
CHARIOTS DE SERVICE

## 10.2 ST/STEEL RAIL TROLLEYS

295

CARROS GUÍAS EN ACERO INOXIDABLE  
CHARIOTS À GLISSIÈRES EN ACIER INOXYDABLE

## 10.3 DISH TROLLEYS

302

CARROS PARA PLATOS  
CHARIOTS À VAISSELLE

## 10.4 SPECIAL TROLLEYS

305

CARROS ESPECIALES  
CHARIOTS SPÉCIAUX

# 10.1 Serving trolleys

Carros de servicio / chariots de service

**Foldable service trolley**  
Carro de servicio plegable  
Chariot de service pliable



**EASILY COLLAPSIBLE in half with a safety latch.**  
FACILMENTE PLEGABLE por la mitad con pestillo de seguridad.  
FACILEMENT PLIABLE en deux avec loquet de sécurité.



**4 revolving casters, 2 with brakes**  
4 ruedas giratorias 2 de las cuales con freno  
4 roues pivotantes, dont 2 avec frein



**Total maximum load 150 kg. Max. load per level 50 kg**  
Carga máxima total 150 KG. Carga máxima por estante 50 kg  
Charge maximale total 150 kg. Charge maximale per niveau 50 kg

REF	Shelf dimension Dim. Estante / Dim. Niveau cm	Shopping cart icon
P642100	82,5 x 50	1/1

# Serving trolleys 10.1

Carros de servicio / chariots de service

**Multi purpose cart**  
Carro de servicio  
Chariot de service



**Maximum weight load 120 kgs**  
Carga máxima 120 kgs  
Charge maximale 120 kgs

**Aluminium supports**  
Soportes de aluminio  
Supports en aluminium

REF	Shelf dimension Dim. Estante / Dim. Niveau cm	Shopping cart icon
P641100	78 x 48,5	1/1

**Silverware container**  
Contenedor para cubiertos  
Conteneur pour couverts



REF	cm	Lts	Shopping cart icon
P642000	32 x 19,5 x 16,5	8	1/1

**Aluminium clearing trolley**  
Carro aluminio desembarace  
Chariot débarrassage en aluminium



**Set trolley**  
Conjunto carro  
Ensemble chariot



**Maximum weight load 120 kgs**  
Carga máxima 120 kgs  
Charge maximale 120 kgs

**Aluminium supports**  
Soportes de aluminio  
Supports en aluminium

REF	Shelf dimension Dim. Estante / Dim. Niveau cm	Shopping cart icon
P640000	78 x 48,5	1/1

**Refuse container**  
Contenedor para desperdicios  
Conteneur pour déchets



REF	cm	Lts	Shopping cart icon
P643000	33,5 x 23 x 56	30	1/1

**EXCLUSIVE**

**Racks adjustable to 1/1 GN containers and FLAP-RACK® (500 x 500 mm). Maximum load: 150 Kg and max. per level 75 Kg.**

Medidas de estantes adaptables a cubetas GN 1/1 y cestas FLAP-RACK® (500 x 500 mm). Carga máxima: total 150 Kg y con un máximo de 75 Kg por estante.

Clayettes adaptables à des bacs GN 1/1 et à casiers à vaisselle FLAP-RACK® (500 x 500 mm). Charge maximale: total 150 Kg et 75 Kg par niveau.

REF	Shelf dimension Dim. Estante / Dim. Niveau cm	Shopping cart icon
P80900	87 x 55,5	1/1

# 10.1 Serving trolleys

Carros de servicio / chariots de service

## St/steel serving trolley

Carro servicio acero inox  
Chariot service en acier inox

### 1.5 mm thick St/Steel tubular frame

Estructura tubular en acero inox de 1.5 mm espesor  
Structure tubulaire en acier inoxydable 1.5 mm. épaisseur

### Total maximum load 240 kg. Max. load per level 80 kg

Carga máxima total 240 KG.  
Carga máxima por estante 80 kg  
Charge maximale total 240 kg.  
Charge maximale per niveau 80 kg

### 12 cm diam. Revolving casters. Two with brakes

Ruedas giratorias de 12 cm diámetro. Dos con frenos  
Roues giratoires de 12 cm diam. Deux avec freins

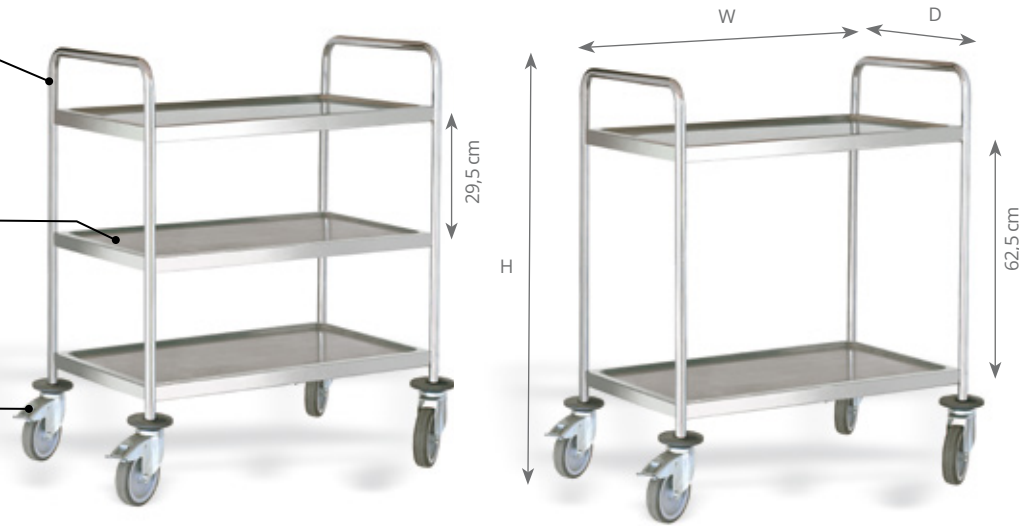

REF	Levels Estantes Niveaux	Shelf dimension Dim. Estante Dim. Niveau cm	W x D x H cm	
P80240	2	80 x 50	88 x 58 x 101,5	1/1
P80250	2	90 x 50	98 x 58 x 101,5	1/1
P80260*	2	100 x 60	108 x 68 x 101,5	1/1
P80270	3	80 x 50	88 x 58 x 101,5	1/1
P80280	3	90 x 50	98 x 58 x 101,5	1/1
P80290*	3	100 x 60	108 x 68 x 101,5	1/1
P80300	4	80 x 50	88 x 58 x 130	1/1
P80310	4	90 x 50	98 x 58 x 130	1/1
P80320*	4	100 x 60	108 x 68 x 130	1/1

\* Thicker shelves  
Estantes de chapa de mayor espesor  
Plateaux plus épais

### Polyamide casters available

Ruedas de poliamida disponibles.  
Roulettes polyamide disponibles.



## Cutlery dispenser for serving trolley

Cubertero para carro servicio  
Ramasse-couverts pour chariot service



REF	Mod	H cm	
P80374	GN 1/3	15	1/1

## St/Steel clearing trolley

Carro desembarace inox  
Chariot de débarrassage en inox

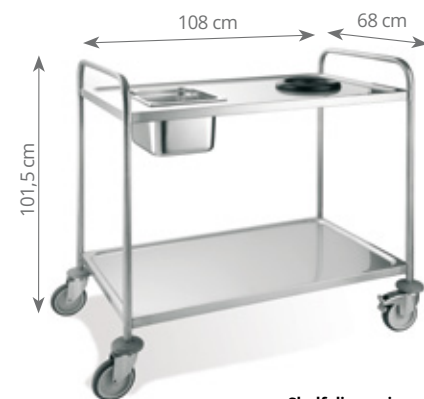

REF	Levels Estantes Niveaux	Shelf dimension Dim. Estante / Dim. Niveau cm	
P80680	2	100 x 60	1/1

### Polyamide casters available

Ruedas de poliamida disponibles.  
Roulettes polyamide disponibles.

### GN container not included

GN no incluida  
Bac GN non inclus  
Ø 165 mm



Easy and quick assembly  
Facilidad y rapidez de montaje  
Montage facile et rapide



Total maximum load 240 kg  
Max. load per level 80 kg  
Carga máxima total 240 kg  
Carga máxima por estante 80 kg  
Charge maximale total 240 kg  
Charge maximale per niveau 80 kg



12 cm diam. Revolving casters. Two with brakes  
Ruedas giratorias de 12 cm diámetro. Dos con frenos  
Roues giratoires de 12 cm diam. Deux avec freins

## Disassembled trolley

Carro desmontable  
Chariot démontable

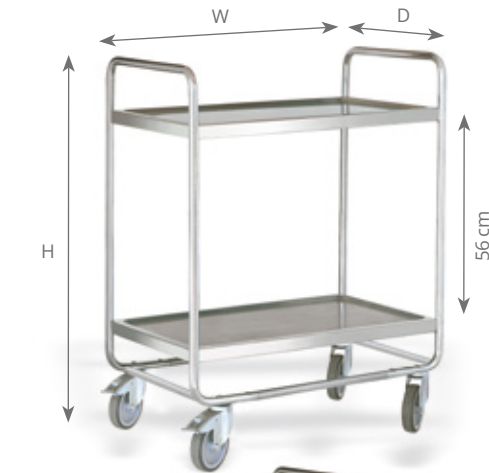

Very strong and resistant once assembled  
Muy robustos y sólidos  
Très robustes et solides une fois montés

Delivered flatpacked.  
Se entregan desmontados.  
Livrés démontés.

REF	Levels Estantes Niveaux	Shelf dimension Dim. Estante Dim. Niveau cm	W x D x H cm	
P80330	2	80 x 50	81 x 54,5 x 104	1/1
P80340	2	90 x 50	91 x 54,5 x 104	1/1
P80350	3	80 x 50	81 x 54,5 x 104	1/1
P80360	3	90 x 50	91 x 54,5 x 104	1/1

# Serving trolleys 10.1

Carros de servicio / chariots de service



## Serving trolley with guard-rail shelf

Carro servicio con barandilla  
Chariot service avec galerie

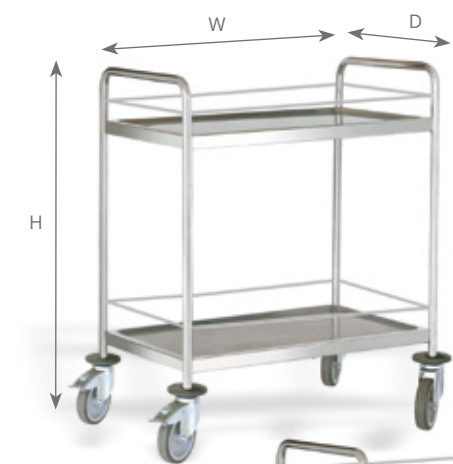

Polyamide casters available  
Ruedas de poliamida disponibles  
Roulettes polyamide disponibles

REF	Levels Estantes Niveaux	Shelf dimension Dim. Estante Dim. Niveau cm	W x D x H cm	
P80940	2	80 x 50	88 x 58 x 101,5	1/1
P80941	3	80 x 50	88 x 58 x 101,5	1/1

# 10.1 Serving trolleys

Carros de servicio / chariots de service

## Service trolley in black

Carro de servicio en color negro

Chariot de service de couleur noire



**Total maximum load 150 kg.**  
**Max. load per level 50 kg**

Carga máxima total 150 KG.  
Carga máxima por estante 50 kg

Charge maximale total 150 kg.  
Charge maximale per niveau 50 kg

**4 revolving casters,**  
**2 with brakes**

4 ruedas giratorias  
2 de las cuales con freno

4 roues pivotantes,  
dont 2 avec frein



REF	Shelf dimension Dim. Estante / Dim. Niveau cm	
P80980	82,5 x 50	1/1



## Three-shelf heavy-duty stainless steel cart

Carro de servicio de 3 niveles

Chariot service à trois étagères



# Serving trolleys 10.1

Carros de servicio / chariots de service

**400 kg capacity is distributed between the shelves.**  
*La capacidad de 400 kg se distribuye entre las estanterías.*  
La capacité de 400 kg est répartie entre les rayonnages.

**Two 10 cm wivel casters and two 20 cm front casters ensure swift maneuvering.**  
*Dos ruedas giratorias de 10 cm y dos ruedas delanteras de 20 cm garantizan una maniobra rápida.*  
Deux roues pivotantes de 10 cm et deux roues avant de 20 cm garantissent une manœuvre rapide.

**Extended-height stainless steel handles feature a casters coating.**  
*Los mangos de acero inoxidable de altura extendida cuentan con un revestimiento de confort.*  
Les poignées en acier inoxydable à hauteur prolongée sont dotées d'un revêtement de confort.

REF	Shelf dimension Dim. Estante Dim. Niveau cm	
97208	89 x 58,4	1/1

## Light disassembled trolley

Carro desmontable ligero

Chariot démontable légère

**ECONOMIC LINE**  
**GAMA ECONÓMICA**  
**GAMME ECONOMIQUE**



**Casters Ø 10 cm. Two with brakes.**  
*Ruedas acero Ø 10 cm. Dos con freno.*  
Roulettes Ø 10 cm. Deux avec freins.



**Total maximum load 150 kg.**  
**Max. load per level 50 kg**

Carga máxima total 150 KG.  
Carga máxima por estante 50 kg

Charge maximale total 150 kg.  
Charge maximale per niveau 50 kg

REF	Levels Estantes Niveaux	Shelf dimension Dim. Estante Dim. Niveau cm	W x D x H cm	
P80960	2	84,5 x 52,5	91 x 58,5 x 94,5	1/1
P80961	3	84,5 x 52,5	91 x 58,5 x 94,5	1/1

## Three-shelf tubular cart

Carro tubular de 3 estantes

Chariot tubulaire à 3 étagères



**Total maximum load 225 kg.**  
**Carga máxima total 225 KG.**  
Charge maximale total 225 kg.

REF	Shelf dimension Dim. Estante Dim. Niveau cm	
97168	85 x 54	1/1

# 10.1 Serving trolleys

Carros de servicio / chariots de service

## Paneled serving trolley

Carro servicio panelado  
Chariot service panelé



REF	Shelf dimension		Shopping icon
	Dim. Estante / Dim. Niveau	cm	
P80282	90 x 50	1/1	

### 1.5 mm thick St/Steel tubular frame

Estructura tubular en acero inox de 1.5 mm espesor  
Structure tubulaire en acier inoxydable 1.5 mm. épaisseur

### Paneled

Panelado  
Panelé

### Total maximum load 240 kg Max. load per level 80 kg

Carga máxima total 240 kg  
Carga máxima por estante 80 kg  
Charge maximale total 240 kg  
Charge maximale per niveau 80 kg

### 12 cm diam. Revolving casters. Two with brakes

Ruedas giratorias de 12 cm diámetro.  
Dos con frenos  
Roues giratoires de 12 cm diam.  
Deux avec freins

## Bussing cart

Carro de transporte  
Chariot de transport



REF	Shelf dimension		Shopping icon
	Dim. Estante / Dim. Niveau	cm	
97181	69 x 45	1/1	

**Bins not included**  
Cubetas no incluidas  
Bacs non inclus.

### Durable stainless steel construction and ABS handle provide years of service.

La construcción duradera de acero inoxidable y el mango de ABS proporcionan años de servicio.  
La construction durable en acier inoxydable et la poignée en ABS offrent des années de service.

### Total maximum load 135 kg Carga máxima total 135 kg Charge maximale total 135 kg

### Black vinyl finish creates an attractive appearance

El acabado de vinilo negro crea un aspecto atractivo  
La finition en vinyle noir crée un look attrayant

### Strong swivel casters ensure swift maneuvering

Las ruedas giratorias fuertes garantizan una maniobra rápida  
Des roues pivotantes robustes garantissent une manœuvre rapide

# St/steel rail trolleys 10.2

Carros guías en acero inoxidable / Chariots à glissières en acier inoxydable



## 15 rails trolley for 1/1 GN pans and pastry baking trays.

Carro 15 guías compatible con GN 1/1 y bandejas de pastelería.  
Chariot 15 glissières pour bacs GN 1/1 et plaques pâtisserie

### 2 in 1 rail, suitable for 1/1 GN containers and 60x40 cm pastry trays

Guía 2 en 1, apta para cubetas GN 1/1 y bandejas de pastelería de 60x40 cm  
Glissière 2 en 1, compatible avec bacs GN 1/1 et plaques pâtisserie 60x40 cm

### Max. total load: 240 kg. Carga máx. total 240 kg. Charge max. totale : 240 kg.

### Swivel casters with 12,5 cm diameter. Two with brakes.

Ruedas giratorias de 12,5 cm de diámetro.  
Dos con freno  
Roulettes pivotantes de 12,5 cm de diámetro.  
Deux avec frein.

REF	Entrance / Entrada / Entré	Shopping icon
	cm	
P80600	32,5 - 40 cm	1/1

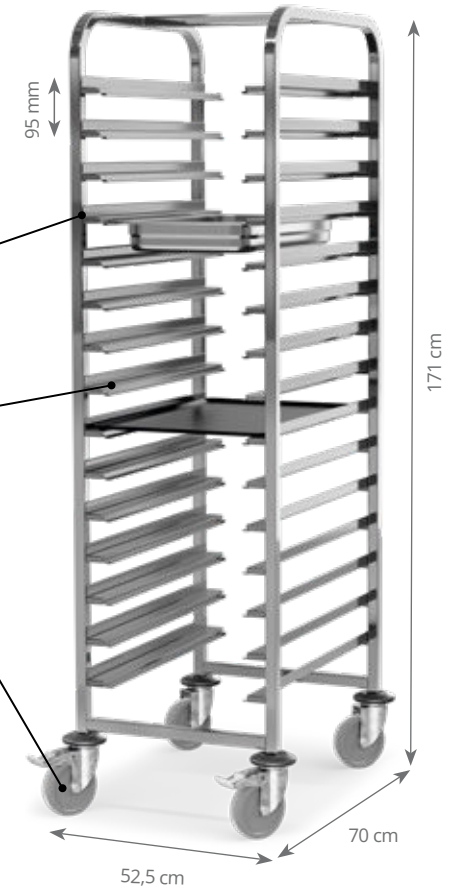

2 IN 1

NEW

## 17 Rails trolley for 1/1 GN pans

Carro 17 guías gn 1/1  
Chariot 17 glissières pour bacs gn 1/1



Polyamide casters available  
Ruedas de poliamida disponibles  
Roulettes polyamide disponibles

REF	Entrance / Entrada / Entré	Shopping icon
	cm	
P80430	32,5	1/1

## Double rail trolley 17x2 for 1/1 GN pans

Carro doble 17x2 guías gn 1/1  
Chariot double 17x2 glissières pour bacs gn 1/1



Polyamide casters available  
Ruedas de poliamida disponibles  
Roulettes polyamide disponibles

REF	Entrance / Entrada / Entré	Shopping icon
	cm	
P80670	32,5	1/1

## 10.2 St/steel rail trolleys

Carros guías en acero inoxidable / Chariots à glissières en acier inoxydable

### Disassembled trolley 17 rails for 1/1 GN pans

Carro desmontable 17 guías gn 1/1

Chariot démontable 17 glissières pour bacs gn 1/1



Polyamide casters available  
Ruedas de poliamida disponibles  
Roulettes polyamide disponibles

REF	Entrance / Entrada / Entré cm	
P80470	32,5	1/1

### Light disassembled trolley 17 rails for 1/1 GN pans

Carro desmontable ligero 17 guías gn 1/1

Chariot démontable léger 17 glissières pour bacs gn 1/1

ECONOMIC LINE  
GAMA ECONÓMICA  
GAMME ECONOMIQUE



Casters Ø 120 mm. Two with brakes.  
Ruedas acero Ø 120 mm. Dos con freno.  
Roulettes Ø 120 mm. Deux avec freins.

REF	Entrance / Entrada / Entré cm	
P80970	32,5	1/1

### Stackable trolley 17 rails for 1/1 GN pans

Carro encastrable 17 guías GN 1/1

Chariot emboîtable 17 glissières pour bacs GN 1/1



Stackable  
Encastrable  
Emboîtable

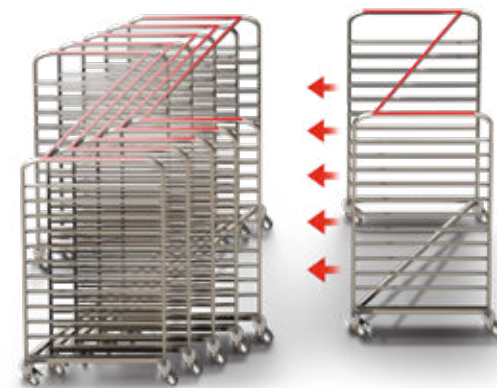

Polyamide casters available  
Ruedas de poliamida disponibles  
Roulettes polyamide disponibles

REF	Entrance / Entrada / Entré cm	
P80520	32,5	1/1

SS  
Stainless  
steel

## St/steel rail trolleys 10.2

Carros guías en acero inoxidable / Chariots à glissières en acier inoxydable

### 17 Rails trolley for 2/1 GN pans

Carro 17 guías GN 2/1

Chariot 17 glissières pour bacs GN 2/1



Polyamide casters available  
Ruedas de poliamida disponibles  
Roulettes polyamide disponibles

REF	Entrance / Entrada / Entré cm	
P80440	53	1/1

### Disassembled trolley 17 rails for 2/1 GN pans

Carro desmontable 17 guías GN 2/1

Chariot démontable 17 glissières pour bacs GN 2/1

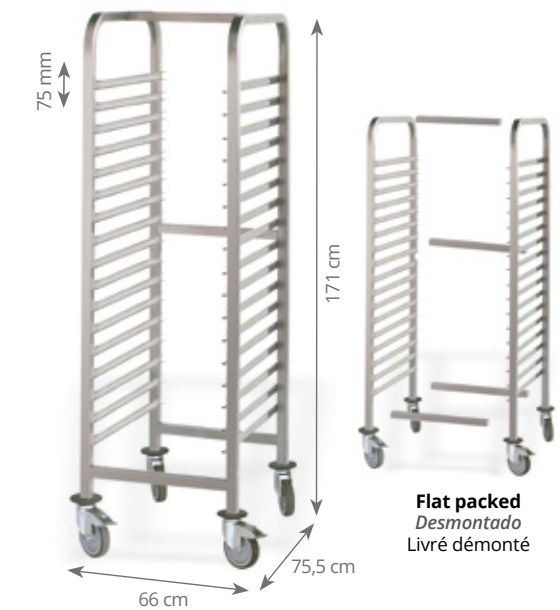

Polyamide casters available  
Ruedas de poliamida disponibles  
Roulettes polyamide disponibles

REF	Entrance / Entrada / Entré cm	
P80480	53	1/1

### Stackable trolley 17 rails for 2/1 GN pans

Carro encastrable 17 guías GN 2/1

Chariot emboîtable 17 glissières pour bacs GN 2/1



Stackable  
Encastrable  
Emboîtable

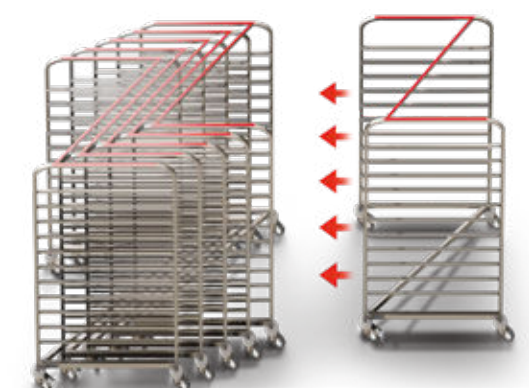

Polyamide casters available  
Ruedas de poliamida disponibles  
Roulettes polyamide disponibles

REF	Entrance / Entrada / Entré cm	
P80510	53	1/1

# 10.2 St / steel rail trolleys

Carros guías en acero inoxidable / Chariots à glissières en acier inoxydable

## Pastry baking tray trolley

Carro bandejas pastelería  
Chariot pour plaques à pâtisserie



Entrance 40 cm  
Entrada 40 cm  
Entrée 40 cm

Polyamide casters available  
Ruedas de poliamida disponibles  
Roulettes polyamide disponibles

REF	Nr. of Levels Nº Guías Num. Niveaux	Size of rails Medida guías Dim. glissières cm	Dist. betw. rails Dist. entre guías Esp. entre glis. cm	Shopping icon
P80840	15	60 x 40	8,5	1/1
P80850	20	60 x 40	7,0	1/1
P80460	30	60 x 40	4,5	1/1

## Disassembled rail trolley for bakery

Carro desmontable bandejas pastelería  
Chariots démontable pour plaques à pâtisserie



Flat packed  
Desmontado  
Livré démonté

Entrance 40 cm  
Entrada 40 cm  
Entrée 40 cm

Polyamide casters available  
Ruedas de poliamida disponibles  
Roulettes polyamide disponibles

REF	Nr. of Levels Nº Guías Num. Niveaux	Size of rails Medida guías Dim. glissières cm	Dist. betw. rails Dist. entre guías Esp. entre glis. cm	Shopping icon
P80870	15	60 x 40	8,5	1/1
P80880	20	60 x 40	7,0	1/1
P80500	30	60 x 40	4,5	1/1

## Disposable trolley covers dispenser

Dispensador para fundas de carro  
Distributeur pour housses de chariot

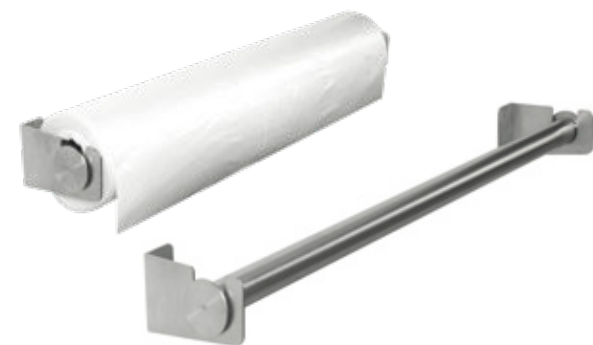

REF	W x D x H cm	Shopping icon
P80641	91,5 x 16 x 10	1/1

## Disposable covers for trolleys

Fundas desechables de polietileno para carros  
Housses jetables pour chariots



### Pack / Rollo / Rouleau 100 u

Medium density polyethylene.  
Polietileno de densidad media.  
Poliéthylène de densité moyenne.

For high trolleys.  
Para carros altos.  
Pour chariots hauts.

REF	Description	Shopping icon
P80610	for trolley 1/1 / para carro 1/1 / pour chariot 1/1	1/1
P80620	for trolley 2/1 / para carro 2/1 / pour chariot 2/1	1/1
P80630	for pastry trolley 600 x 400 / para carro pastelería 600 x 400 / pour chariot pâtisserie 600 x 400	1/1



# St / steel rail trolleys 10.2

Carros guías en acero inoxidable / Chariots à glissières en acier inoxydable

## Defrost trolley 9 rails

Carro descongelación 9 guías  
Chariot à dégivrage 9 glissières

PATENTED



Drain in each shelf  
Cada nivel tiene un desagüe  
Chaque niveau est pourvu d'une évacuation

Tray to collect thawing condensate  
Cubeta para recoger el agua de descongelación  
Bac pour recueillir l'eau de décongélation

Space saver while foodstuff defrost.  
Ahorro de espacio en el proceso de descongelado de los alimentos.  
Economie d'espace pendant le dégivrage des aliments.

Polyamide casters available  
Ruedas de poliamida disponibles  
Roulettes polyamide disponibles

REF	Mod	W x D x H cm	Entrance Entrada Entrée cm	Shopping icon
P80810	GN 2/1	66,5 x 75,5 x 171	53,0	1/1
P80813	GN 1/1	45,5 x 63,0 x 171	32,5	1/1

## Special GN container for defrost trolley

Cubeta especial GN para carro descongelación  
Bac GN spécial pour chariot dégivrage



Container with drainer hole.  
Cubeta con desagüe.  
Bac avec dégorgeement.

REF	Mod	cm	Lts	H cm	Shopping icon
P80811	GN 2/1	65 x 53	28,9	10	1/1
P80814	GN 1/1	53 x 32,5	14,2	10	1/1

## Perforated bottom

Fondo perforado para cubeta  
Egouttoir pour bac



<sup>1</sup> Recommended for item code P80811  
Recomendado para ref. P80811  
Recommandé pour réf. P80811

<sup>2</sup> Recommended for item code P80814  
Recomendado para ref. P80814  
Recommandé pour réf. P80814

REF	Mod	Shopping icon
P215000 <sup>1</sup>	GN 2/1	1/1
P115000 <sup>2</sup>	GN 1/1	1/1

## 10.2 St/steel rail trolleys

Carros guías en acero inoxidable / Chariots à glissières en acier inoxydable

### Self-service trolley 12 rails

Carro self-service 12 guías  
Chariot self-service 12 glissières

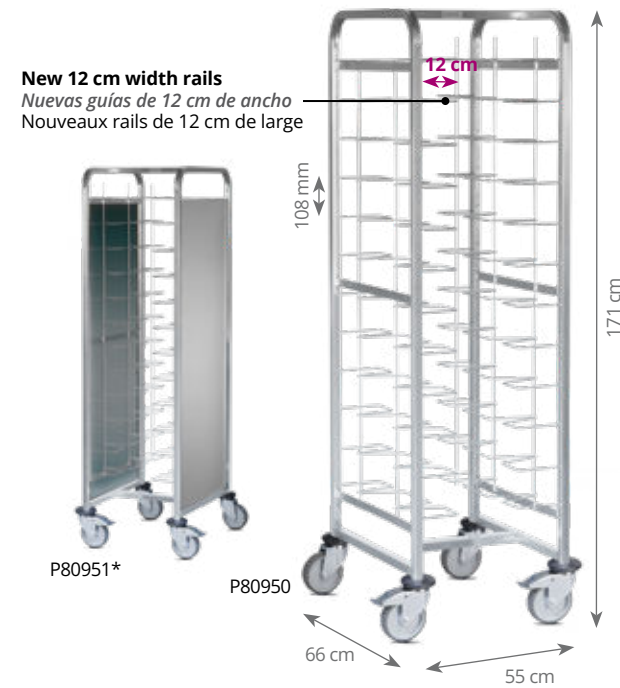

Suitable for trays from 32,5 to 52,5 cm.  
Compatible con bandejas de 32,5 a 52,5 cm.  
Adaptable pour plaques de 32,5 a 52,5 cm.

Entrance 42 cm  
Entrada 42 cm  
Entrée 42 cm

Compatible with all Pujadas fast food trays  
Todas las bandejas Pujadas fast food ref.  
Toutes les plaques Pujadas fast food  
P8610/ 86100/ P340

REF	
P80950	1/1
P80951*	1/1

\* With two side panels made of aluminium+composite.  
\* Con dos paneles laterales composite+aluminio.  
\* Avec deux panneaux latéraux en composite+aluminium.

### Self-service trolley 24 rails

Carro self-service 24 guías  
Chariot self-service 24 glissières

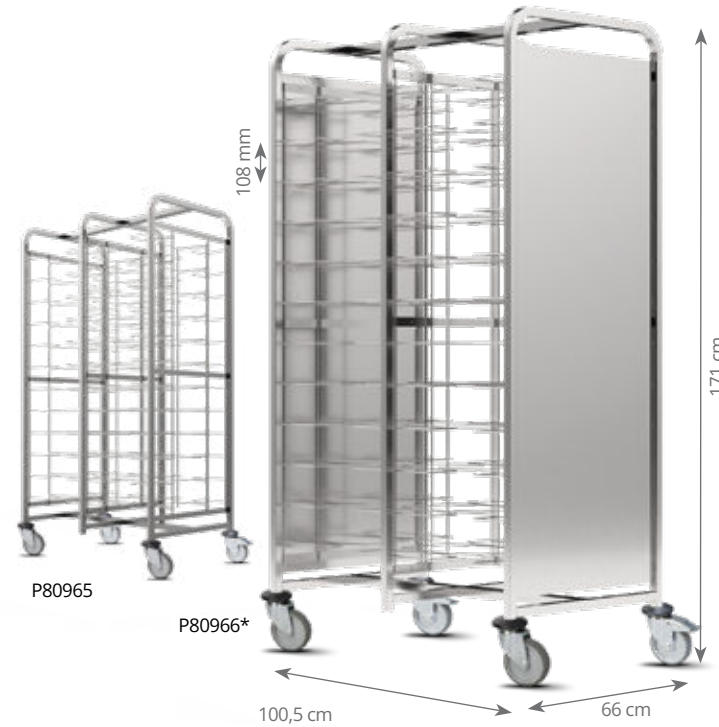

Suitable for trays from 32,5 to 52,5 cm.  
Compatible con bandejas de 32,5 a 52,5 cm.  
Adaptable pour plaques de 32,5 a 52,5 cm.

Entrance 42 cm  
Entrada 42 cm  
Entrée 42 cm

Compatible with all Pujadas fast food trays  
Todas las bandejas Pujadas fast food ref.  
Toutes les plaques Pujadas fast food  
P8610/ 86100/ P340

REF	
P80965	1/1
P80966*	1/1

\* With two side panels made of aluminium+composite.  
\* Con dos paneles laterales composite+aluminio.  
\* Avec deux panneaux latéraux en composite+aluminium.



## St/steel rail trolleys 10.2

Carros guías en acero inoxidable / Chariots à glissières en acier inoxydable

### Double fast-food tray trolley 12 rails

Carro doble para bandejas fast-food 12 guías  
Chariot double pour plateaux fast-food 12 glissières



Suitable for trays 48 x 37 cm  
Ideal para bandejas 48 x 37 cm  
Ideal pour plateaux 48 x 37 cm

Entrance 48 cm  
Entrada 48 cm  
Entrée 48 cm

Polyamide casters available  
Ruedas de poliamida disponibles  
Roulettes polyamide disponibles

REF	Size of rails Medida guías Dimensions glissières cm	
P80910	48 x 80	1/1

### Transport trolley for isothermal trays

Carro transporte bandejas isotérmicas  
Chariot transport plateaux isothermes



Suitable for tray P919000  
Ideal para bandejas P919000  
Ideal pour plateaux P919000

Trolley made of St/Steel and plastic rails.  
Carro fabricado en acero inoxidable y guías de plástico.  
Chariot fabriqué en acier inoxydable et glissières en plastique.

REF	Nr. of Levels Nº Guías Num. Niveaux	Size of rails Medida guías Dim. glissières cm	W x D x H cm	
P925001	10	55 x 37,5	50 x 62 x 152	1/1
P925002	20	55 x 37,5	92 x 62 x 152	1/1

See products on / Ver productos en / Voir produits en page

P. 265

### Polypropylene fast food trays

Bandejas de polipropileno para comida rápida  
Plateaux de restauration rapide en polypropylene



See products on / Ver productos en / Voir produits en page

P. 265

### Isothermal tray

Bandeja isotérmica  
Plateau Isotherme



## 10.3 Dish trolleys

Carros para platos / Chariots à vaisselle

### Dish trolley

Carro para platos  
Chariot à vaisselle

CS  
Carbon steel

REF	W x D x H cm	
P80790	58 x 71 x 177,5	1/1

The distance between levels is 5,8 cm  
Distancia entre niveles 5,8 cm.  
Distance entre les niveaux 5,8 cm.

Carbon steel with anti-corrosion coating  
Acero al carbono con recubrimiento anticorrosivo  
Acier au carbone avec revêtement anti-corrosion

Strong welded structure handle for easy transport  
Resistente estructura soldada con asa para fácil transporte.  
Structure soudée robuste avec poignée pour un transport facile.

Capacity for 100 dishes. Different sizes of dishes can be combined thanks to its adjustable system.

Capacidad para 100 platos. Se pueden combinar diferentes tamaños de platos gracias a su sistema ajustable.

Capacité pour 100 assiettes. Différentes tailles de plats peuvent être combinées grâce à son système réglable.

(Ø máx. 34,5cm)

4 casters of 125mm with bumpers.  
2 casters brakes included.

4 ruedas de 12,5 cm con parachoques.  
2 ruedas con freno.

4 roues de 125 mm avec pare-chocs.  
2 roulettes avec freins

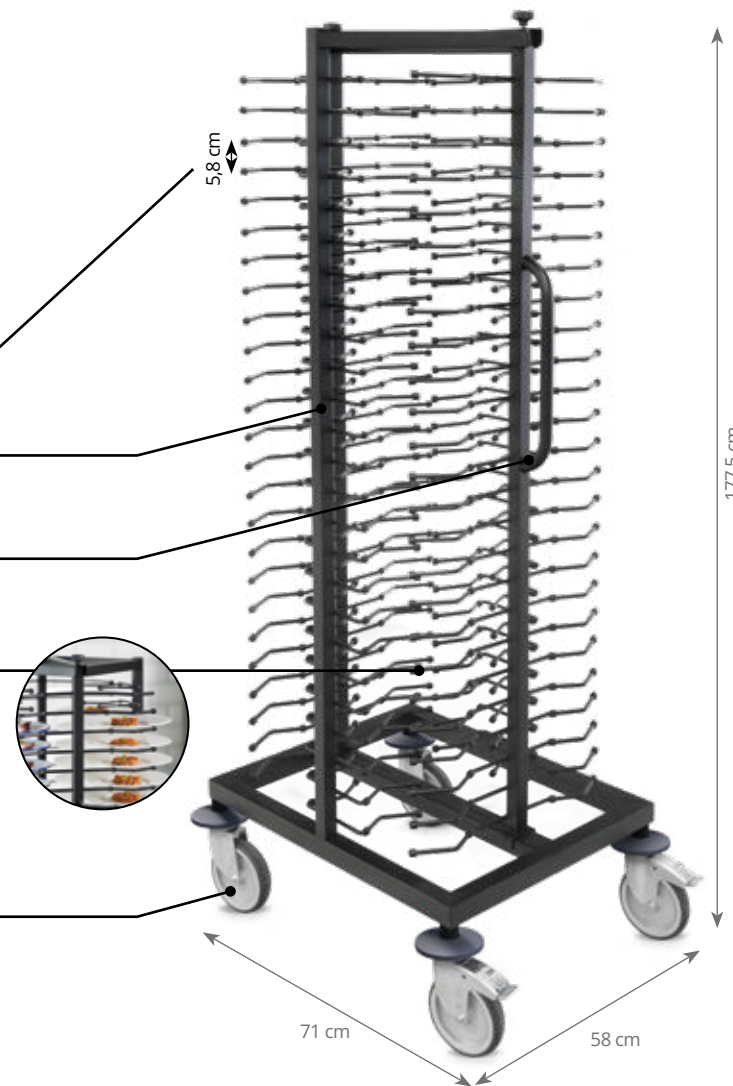

### Dish trolley cover

Funda carro platos  
Housse pour chariot à vaisselle

PE  
Polyethylene

NEW

REF	W x D x H cm	
P80793	62 x 71 x 152	1/1

4 zippers for easy access from any point  
4 cremalleras para una fácil accesibilidad desde cualquier punto  
4 fermetures éclair pour un accès facile depuis n'importe quel point

Handle opening for easier transport  
Apertura para el asa facilitando el transporte  
Ouverture pour la poignée facilitant le transport

Made of reinforced high-density polyethylene  
Fabricada en polietileno de alta densidad reforzado  
Fabriqué en polyéthylène haute densité renforcé



Clear  
Transp.



## Dish trolleys 10.3

Carros para platos / Chariots à vaisselle

SS  
Stainless steel

Robust, resistant structure.  
Estructura robusta y resistente.  
Structure robuste et résistante.

Includes two plate panels (dividers) made from stainless steel, which can be adjusted as required.

Se incluyen 2 paneles (separadores) de platos fabricados en acero inoxidable y ajustables según las necesidades.

2 panneaux (séparateurs) d'assiettes en acier inoxydable sont inclus et peuvent être réglés selon les besoins.

Base tilted inwards to prevent plates falling.

Base inclinada hacia el interior para evitar la caída de los platos.

Base inclinée vers l'intérieur pour éviter que les assiettes ne tombent.

4 casters of 125mm with bumpers.  
2 casters brakes included.

4 ruedas de 12,5 cm con parachoques.  
2 ruedas con freno.

4 roues de 125 mm avec pare-chocs.  
2 roulettes avec freins

### Dish trolley

Carro para platos  
Chariot à vaisselle



Can hold 150 plates of up to Ø 32 cm.

Permite una carga de 150 platos de hasta Ø 32 cm.  
Permet une charge de 150 assiettes jusqu'à Ø 32 cm.

REF	W x D x H cm	
P80791	105 x 50 x 85	1/1

### Double dish trolley

Carro para platos doble  
Chariot à vaisselle double



Can hold 300 plates of up to Ø 32 cm.

Permite una carga de 300 platos de hasta Ø 32 cm.  
Permet une charge de 300 assiettes jusqu'à Ø 32 cm.

REF	W x D x H cm	
P80792	105 x 78 x 85	1/1

# 10.3 Dish trolleys

Carros para platos / Chariots à vaisselle



**Adjustable dish caddy**  
Carro ajustable para platos  
Chariot modulable pour assiettes



Delivered with 4 posts plus 1 protection cover.  
Se sirve con 4 columnas separadoras más una funda protectora.  
Livré avec 4 colonnes de séparation et 1 housse de protection.

Unique and easy adjustment from the top.  
Ajuste único y fácil por la parte superior.  
Reglage unique et facile de la partie supérieure.

COMBINATIONS  
COMBINACIONES  
COMBINATIONS  
Size plates  
Tamaño platos  
Taille assiettes

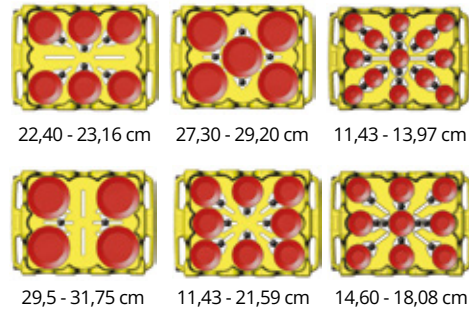

REF  
ADC-4 1/1

**Adjustable caddy for square & round dishes**  
Carro ajustable para platos cuadrados y redondos  
Chariot modulable pour assiettes carrées et rondes

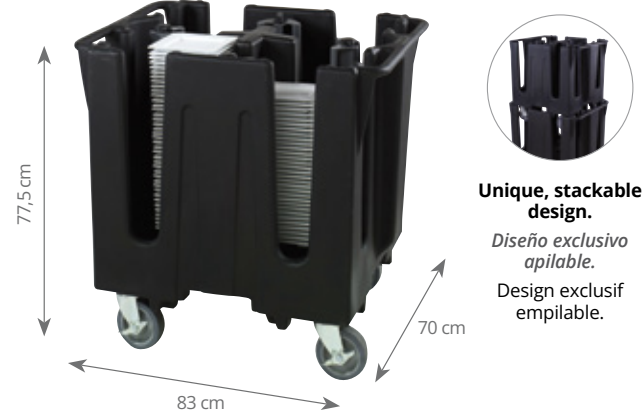

Delivered with 5 posts, one of them in cross shape plus 1 protection cover.  
Se sirve con 5 columnas separadoras una de ellas en forma de cruz más una funda protectora.  
Livré avec 5 colonnes de séparation une desquelles en forme de croix plus 1 housse de protection.

Unique and easy adjustment from the top.  
Ajuste único y fácil por la parte superior.  
Reglage unique et facile de la partie supérieure.

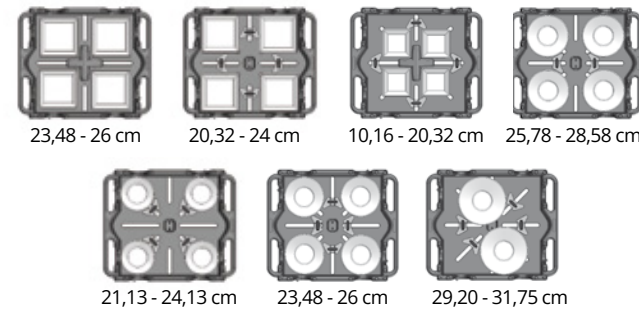

REF  
SAC-SQ5-06 1/1

**Post for dish caddy**  
Columna separadora carro platos  
Colonne séparation chariot assiettes



Compatible ref. ADC-4  
Compatible ref. SAC-SQ5-06  
Compatible réf.

REF  
ADP 1/1

**Vinyl cover for dish caddy**  
Funda protectora de vinilo para carro platos  
Housse protection en vynil pour chariot assiettes



Cover for item SAVC. Funda para ref. ADC-4  
Housse pour réf. SAC-SQ5-06

REF  
SAVC 1/1



# Special trolleys 10.4

Carros especiales / Chariots spéciaux

**1/1 GN transport trolley**  
Carro portacubetas GN 1/1  
Chariot transport bac GN 1/1



GN containers not included. No incluye cubetas GN. Bacs GN non inclus.  
Polyamide casters available. Ruedas de poliamida disponibles. Roulettes polyamide disponibles

REF  
P80390 1/1

**2/1 GN transport trolley**  
Carro porta cubeta GN 2/1  
Chariot transport bac GN 2/1



GN containers not included. No incluye cubetas GN. Bacs GN non inclus.  
Polyamide casters available. Ruedas de poliamida disponibles. Roulettes polyamide disponibles.  
Perfect for storing and transporting large quantities of prepared food and sauces. Ideales para el almacenaje y transporte de alimentos preparados y salsas en grandes cantidades. Idéales pour le stockage et le transport d'aliments cuisinés et sauces en grandes quantités.

REF  
P80380 1/1

**Tray transport trolley 7 rails**  
Carro transporte bandejas 7 guías  
Chariot transport plateaux 7 glissières

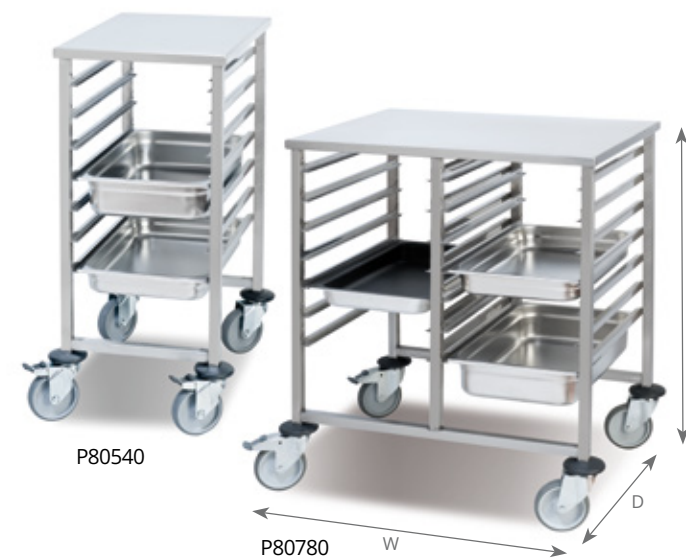

REF	Size of rails Medida guías Dim. glissières cm	W x D x H cm	Dist. betw. rails Dist. entre guías Esp. entre glis. cm	1/1
P80540	GN 1/1	45,5x63,5x90	7,5	1/1
P80550	GN 2/1	66x75x90	7,5	1/1
P80560	60 x 40	52,5x70x90	8,5	1/1
P80780	GN 1/1 Doble	81x63,5x90	7,5	1/1

VOLLRATH

**Trolley cutlery dispenser GN 1/3**  
Carro portacubiertos GN 1/3 y porta bandejas  
Chariot porte-ramasse couverts GN 1/3



GN containers not included. No incluye cubetas GN. Bacs GN non inclus.  
Polyamide casters available. Ruedas de poliamida disponibles. Roulettes polyamide disponibles

REF  
P80740 1/1

305

VOLLRATH

VOLLRATH

304

VOLLRATH

# 10.4 Special trolleys

Carros especiales / Chariots spéciaux



**Dishwasher rack trolley**  
Carro para cestas Vajillas  
Chariot casiers à vaisselle

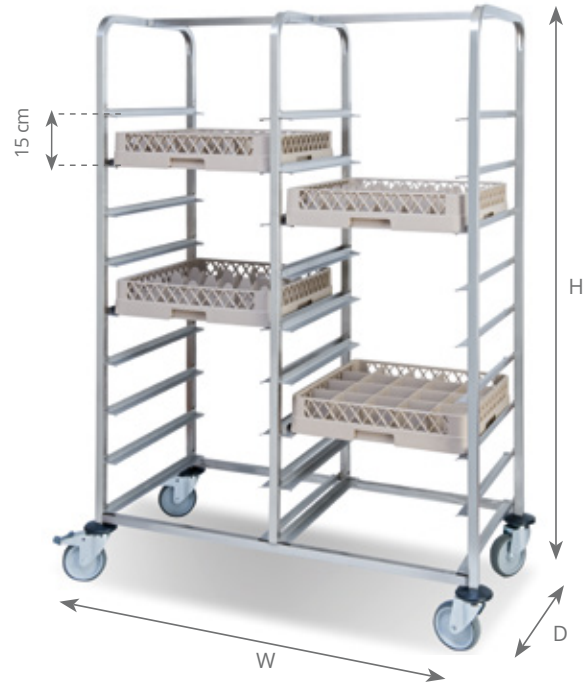

REF	Nr. of Levels Nº Guías Num. Niveaux	Size of rails Medida guías Dim. glissières cm	W x D x H cm	
P80750	5	50 x 50	64 x 63,3 x 116	1/1
P80760	9	50 x 50	64 x 63,3 x 171	1/1
P80770	9	50 x 50 (double / doble)	118,5 x 63,3 x 171	1/1

**Plastic trolley with handle for dishwasher racks**  
Carro de plástico con asa para cestas  
Chariot avec anse pour casiers à vaisselle



**Maximum load: 100 kg**  
Carga máxima: 100 kg  
Charge maximale: 100 kg

REF	H cm	
P5017	98	1/1

**Trolley for heavy loads**  
Carro para cargas pesadas  
Chariot à charges lourdes



**Maximum load: 350 kg**  
Carga máxima: 350 kg  
Charge maximale: 350 kg

REF	
P80570	1/1

**St/steel trolley for dishwasher racks**  
Carro inox para cestas  
Chariot inox pour casiers à vaisselle



**Maximum load: 200 kg**  
Carga máxima: 200 kg  
Charge maximale: 200 kg

REF	H cm		
P80590	16,5	without handle / sin asa / sans anse	1/1
P80580	106,5	with handle / con asa / avec anse	1/1

**Plastic trolley for dishwasher racks**  
Carro de plástico para cestas  
Chariot pour casiers à vaisselle

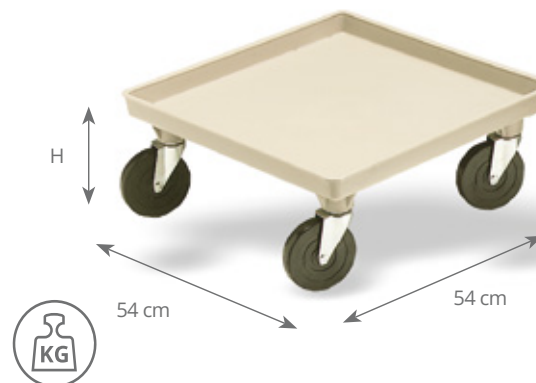

**Maximum load: 100 kg**  
Carga máxima: 100 kg  
Charge maximale: 100 kg

REF	H cm	
P5015	23	1/1

**Plastic trolley for dishwasher racks**  
Carro de plástico para cestas  
Chariot pour casiers à vaisselle



**Maximum load: 150 kg**  
Carga máxima: 150 kg  
Charge maximale: 150 kg

REF	H cm	
1697	23	1/1

# 11 Shelving

Estanterías  
Rayonnages



## 11.1 COMPLETE AND ANGULAR SHELVING 314

ESTANTERÍAS COMPLETAS Y ANGULARES  
RAYONNAGES COMPLETS ET ANGULAIRES

## 11.2 SHELVING WITH CASTERS 320

ESTANTERÍAS CON RUEDAS  
RAYONNAGES AVEC ROUES

## 11.3 BENCH 320

BANCADAS  
BANCS

## 11.4 PARTS 321

COMPONENTES  
COMPOSANTS

## 11.5 BREAKDOWN OF SHELVING SETS 324

DESGLOSE CONJUNTOS DE ESTANTERÍAS  
DÉCOMPOSITION KITS RAYONNAGES

# Modular shelving

Estanterías modulares / Rayonnages modulables



○ -30 °C  
○ +75 °C

Easy and quick assembly  
Facilidad y rapidez de montaje  
Montage facile et rapide



**ANTICORROSIVE - Manufactured with special anodised aluminium**

ANTICORROSIÓN - Fabricadas con estructura de aluminio anodizado

ANTI-CORROSION - Fabriquées avec une structure fabriquée en aluminium anodisé

**Robustness and resistance**

Robustez y resistencia  
Robustesse et résistance

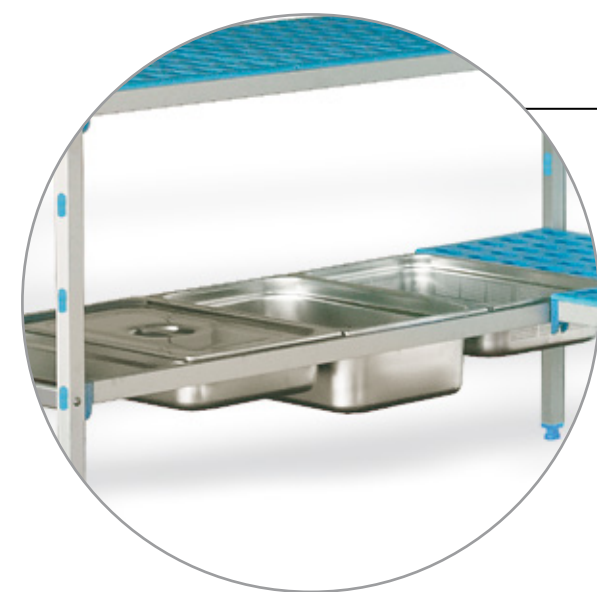

**Compatibility**  
Compatible  
Compatibilité  
GN 1/1 & 2/3



## Rack shelves

Parrillas  
Clayettes

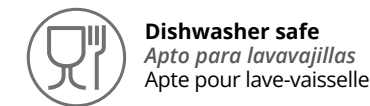
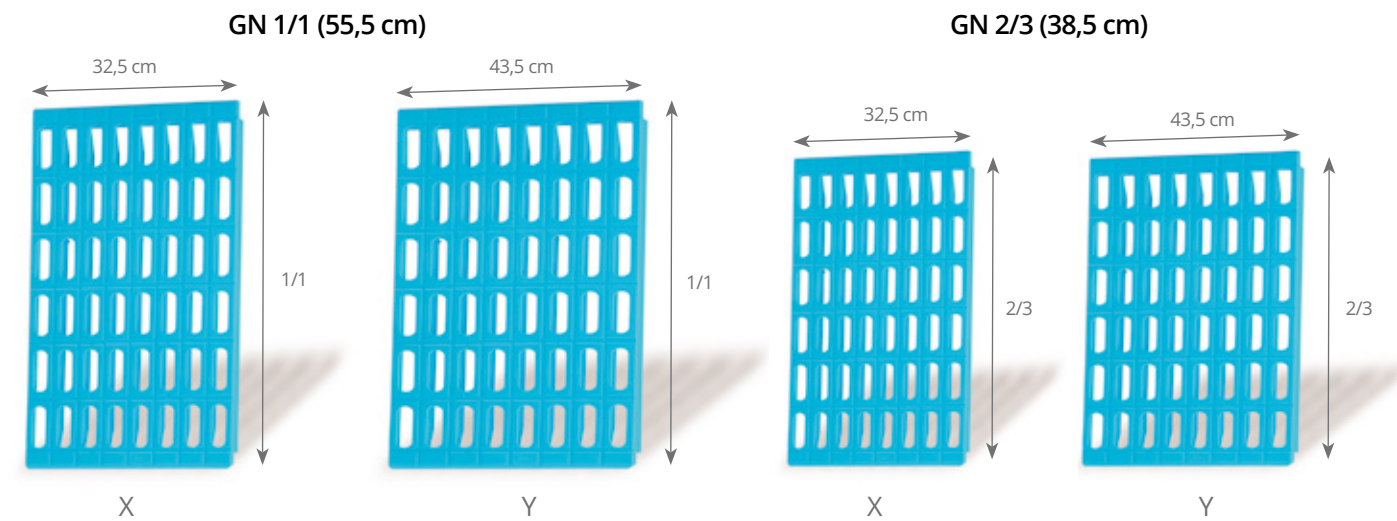

**Dishwasher safe**  
Apto para lavavajillas  
Apte pour lave-vaisselle

**Combining rack shelves among the same group (X/Y) allows to personalize the lengths of each shelf. (Refer to next page for proposed combinations)**

Combinando parrillas de la misma profundidad (X/Y) permite personalizar las longitudes de las estanterías a cada una de las necesidades. (Ver en página siguiente combinaciones propuestas)

En combinant des clayettes de la même profondeur (X/Y) permet de personnaliser les longueurs des rayonnages à tout besoin. (Voir page suivante pour des combinaisons proposées)

## Support for crossbars

Pieza soporte travesaños  
Support pour longerons



**Special fixing system support for crossbars which offers the highest security, reliability and robustness.**

Sistema especial de fijación de soporte para travesaños que ofrece la máxima seguridad, fiabilidad y robustez.

Système spécial de fixation des supports pour longerons qui offre la sécurité, fiabilité et robustesse maximale.

## Adjustable feet

Pies regulables  
Pieds réglables

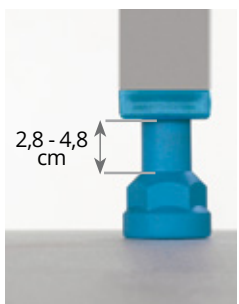

**Levelling feet with hidden thread, for gradient floors. It is also possible to adapt Ø 12,5 cm casters.**

Pies regulables con rosca oculta para suelos con desniveles. Con la posibilidad de adaptar ruedas de Ø 12,5 cm.

Pieds réglables avec filetage caché pour sols irréguliers. Il est aussi possible d'y adapter des roues de Ø 12,5 cm.



# Standard heights of levels

Alturas estándar de los niveles  
Hauteur standard des niveaux

Higher than 200 cm please ask  
Más de 200 cm altura consultar  
Hauteur supérieure à 200 cm veuillez nous consulter

Height 175 cm / 3 levels  
Altura 175 cm / 3 niveles  
Hauteur 175 cm / 3 niveaux

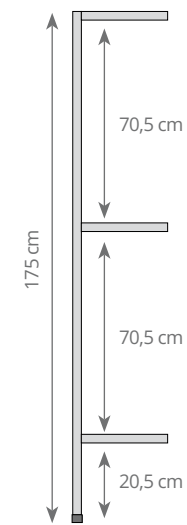

Height 175 cm / 4 levels  
Altura 175 cm / 4 niveles  
Hauteur 175 cm / 4 niveaux

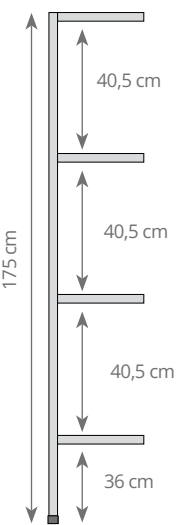

Height 175 cm / 5 levels  
Altura 175 cm / 5 niveles  
Hauteur 175 cm / 5 niveaux

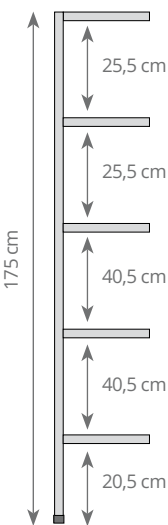

Height 205 cm / 4 levels  
Altura 205 cm / 4 niveles  
Hauteur 205 cm / 4 niveaux

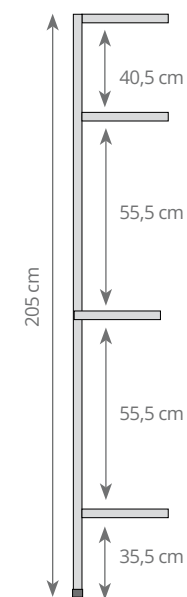

Height 205 cm / 5 levels  
Altura 205 cm / 5 niveles  
Hauteur 205 cm / 5 niveaux

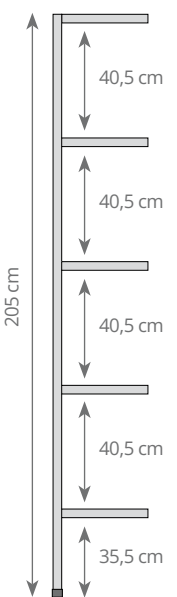

Height 205 cm / 6 levels  
Altura 205 cm / 6 niveles  
Hauteur 205 cm / 6 niveaux

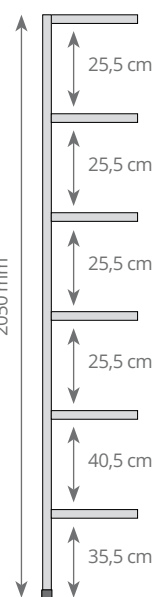

Height 130 cm / 3 levels  
Altura 130 cm / 3 niveles  
Hauteur 130 cm / 3 niveaux

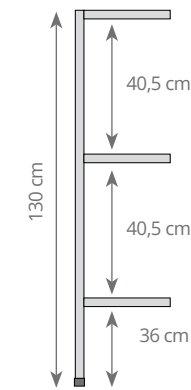

Combinations  
Combinaciones  
Combinaisons

W (cm)	Combinations
65,5	X X
71,5	X X
77	X Y
83	X Y
87,5	Y Y
93,5	Y Y
98,5	X X X
104,5	X X X
109,5	X X Y
115,5	X X Y
120,5	X Y Y
126,5	X Y Y
131,5	Y Y Y or/o/ou X X X X
137,5	Y Y Y or/o/ou X X X X
142	X X X Y
148	X X X Y
153	X X Y Y
159	X X Y Y
164,5	X Y Y Y
170,5	X Y Y Y

# Complete and angular shelving

Estanterías completas y angulares  
Rayonnages complets et angulaires



# 11.1 Full shelf

Estantería completa / Rayonnage complet

**3 Levels**  
Niveles  
Niveaux

**Complete kits**  
Kits completos  
Kits complets

**Diferent combinations**  
Distintas combinaciones  
Diférentes combinaisons

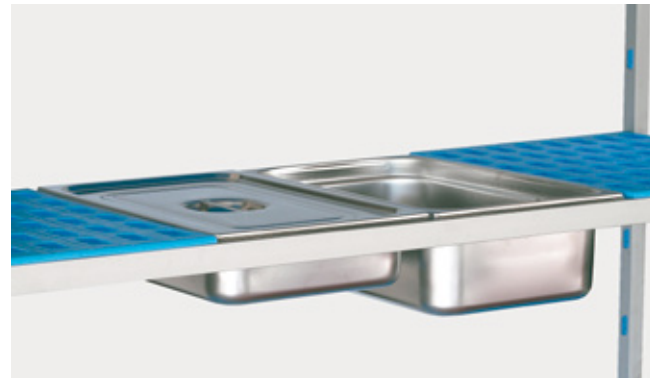

**Compatible with 2/3 containers**  
Compatible con cubetas 2/3  
Compatible avec bacs 2/3

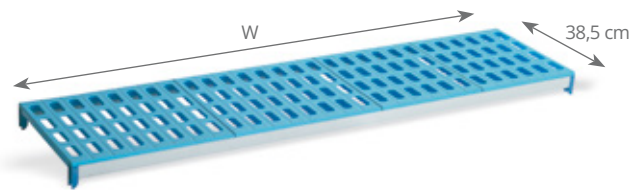

**Compatible with 1/1 containers**  
Compatible con cubetas 1/1  
Compatible avec bacs 1/1

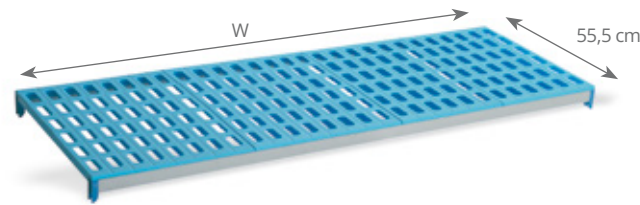

REF	W cm	🛒/📦
P7000	71,5	1/1
P7001	83,0	1/1
P7002	93,5	1/1
P7003	104,5	1/1
P7004	115,5	1/1
P7005	126,5	1/1
P7006	137,5	1/1
P7007	148,0	1/1
P7008	159,0	1/1
P7009	170,5	1/1
P7010	184,0	1/1
P7011	195,0	1/1
P7012	206,0	1/1
P7013	217,0	1/1
P7014	228,0	1/1
P7015	238,8	1/1
P7016	249,6	1/1
P7017	260,8	1/1
P7018	272,0	1/1
P7019	282,5	1/1
P7020	293,0	1/1
P7021	304,0	1/1
P7022	315,0	1/1
P7023	326,5	1/1

REF	W cm	🛒/📦
P7024	338,0	1/1
P7025	351,3	1/1
P7026	362,1	1/1
P7027	372,9	1/1
P7028	384,1	1/1
P7029	395,3	1/1
P7030	406,5	1/1
P7031	417,0	1/1
P7032	427,5	1/1
P7033	438,0	1/1
P7034	449,0	1/1
P7035	460,0	1/1
P7036	471,0	1/1
P7037	482,5	1/1
P7038	494,0	1/1
P7039	505,5	1/1
P7040	518,6	1/1
P7041	529,8	1/1
P7042	541,0	1/1
P7043	551,5	1/1
P7044	562,0	1/1
P7045	572,5	1/1
P7046	583,0	1/1

REF	W cm	🛒/📦
P7141	71,5	1/1
P7142	83,0	1/1
P7143	93,5	1/1
P7144	104,5	1/1
P7145	115,5	1/1
P7146	126,3	1/1
P7147	137,5	1/1
P7148	148,0	1/1
P7149	159,0	1/1
P7150	170,5	1/1
P7151	184,0	1/1
P7152	195,0	1/1
P7153	206,0	1/1
P7154	217,0	1/1
P7155	228,0	1/1
P7156	238,8	1/1
P7157	249,6	1/1
P7158	260,8	1/1
P7159	272,0	1/1
P7160	282,5	1/1
P7161	293,0	1/1
P7162	304,0	1/1
P7163	315,0	1/1
P7164	326,5	1/1

REF	W cm	🛒/📦
P7165	338,0	1/1
P7166	351,3	1/1
P7167	362,1	1/1
P7168	372,9	1/1
P7169	384,1	1/1
P7170	395,3	1/1
P7171	406,5	1/1
P7172	417,0	1/1
P7173	427,5	1/1
P7174	438,0	1/1
P7175	449,0	1/1
P7176	460,0	1/1
P7177	471,0	1/1
P7178	482,5	1/1
P7179	494,0	1/1
P7180	505,5	1/1
P7181	518,6	1/1
P7182	529,8	1/1
P7183	541,0	1/1
P7184	551,5	1/1
P7185	562,0	1/1
P7186	572,5	1/1
P7187	583,0	1/1

**IDEA!** For others heights, see the table (p. 324-327)  
Para otras alturas, consultar el desglose (p. 324-327)  
Pour autres hauteurs, consulter le tableau de décomposition (p. 324-327)

# Shelving for angle 11.1

Estantería angular / Rayonnage angulaire

**3 Levels**  
Niveles  
Niveaux

**Shelvings for angle**  
Estanterías angulares  
Rayonnages angulaires

**Diferent combinations**  
Distintas combinaciones  
Diférentes combinaisons



**Included / Includido / Compris:**  
Hooks to form angles  
Ganchos para formar ángulos  
Crochets pour faire les angles



**Compatible with 2/3 containers**  
Compatible con cubetas 2/3  
Compatible avec bacs 2/3

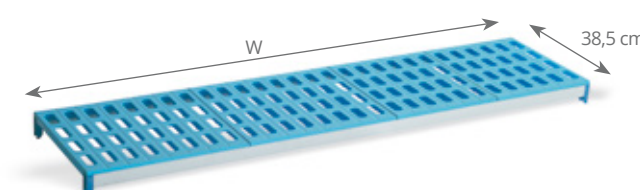

**Compatible with 1/1 containers**  
Compatible con cubetas 1/1  
Compatible avec bacs 1/1

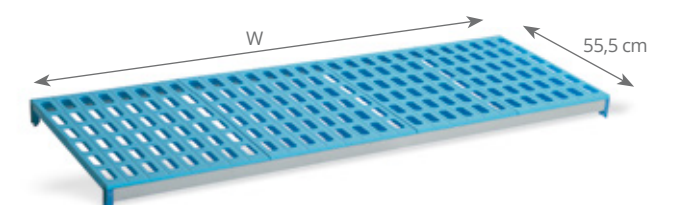

REF	W cm	🛒/📦
P7282	68,5	1/1
P7283	80,0	1/1
P7284	90,5	1/1
P7285	101,5	1/1
P7286	112,5	1/1
P7287	123,3	1/1
P7288	134,5	1/1
P7289	145,0	1/1
P7290	156,0	1/1
P7291	167,5	1/1
P7292	181,0	1/1
P7293	192,0	1/1
P7294	203,0	1/1
P7295	214,0	1/1
P7296	225,0	1/1
P7297	235,8	1/1
P7298	246,6	1/1
P7299	257,8	1/1
P7300	269,0	1/1
P7301	279,5	1/1
P7302	290,0	1/1
P7303	301,0	1/1
P7304	312,0	1/1
P7305	323,5	1/1

REF	W cm	🛒/📦
P7306	335,0	1/1
P7307	348,3	1/1
P7308	359,1	1/1
P7309	369,9	1/1
P7310	381,1	1/1
P7311	392,3	1/1
P7312	403,5	1/1
P7313	414,0	1/1
P7314	424,5	1/1
P7315	435,0	1/1
P7316	446,0	1/1
P7317	457,0	1/1
P7318	468,0	1/1
P7319	479,5	1/1
P7320	491,0	1/1
P7321	502,5	1/1
P7322	515,6	1/1
P7323	526,8	1/1
P7324	538,0	1/1
P7325	548,5	1/1
P7326	559,0	1/1
P7327	569,5	1/1
P7328	580,0	1/1

REF	W cm	🛒/📦
P7423	68,5	1/1
P7424	80,0	1/1
P7425	90,5	1/1
P7426	101,5	1/1
P7427	112,5	1/1
P7428	123,3	1/1
P7429	134,5	1/1
P7430	145,0	1/1
P7431	156,0	1/1
P7432	167,5	1/1
P7433	181,0	1/1
P7434	192,0	1/1
P7435	203,0	1/1
P7436	214,0	1/1
P7437	225,0	1/1
P7438	235,8	1/1
P7439	246,6	1/1
P7440	257,8	1/1
P7441	269,0	1/1
P7442	279,5	1/1
P7443	290,0	1/1
P7444	301,0	1/1
P7445	312,0	1/1
P7446	323,5	1/1

REF	W cm	🛒/📦
P7447	335,0	1/1
P7448	348,3	1/1
P7449	359,1	1/1
P7450	369,9	1/1
P7451	381,1	1/1
P7452	392,3	1/1
P7453	403,5	1/1
P7454	414,0	1/1
P7455	424,5	1/1
P7456	435,0	1/1
P7457	446,0	1/1
P7458	457,0	1/1
P7459	468,0	1/1
P7460	479,5	1/1
P7461	491,0	1/1
P7462	502,5	1/1
P7463	515,6	1/1
P7464	526,8	1/1
P7465	538,0	1/1
P7466	548,5	1/1
P7467	559,0	1/1
P7468	569,5	1/1
P7469	580,0	1/1

**IDEA!** For others heights, see the table (p. 324-327)  
Para otras alturas, consultar el desglose (p. 324-327)  
Pour autres hauteurs, consulter le tableau de décomposition (p. 324-327)

# 11.1 Full shelf

Estantería completa / Rayonnage complet

**4 Levels**  
Niveles  
Niveaux

**Complete kits**  
Kits completos  
Kits complets

**Diferent combinations**  
Distintas combinaciones  
Differentes combinaisons

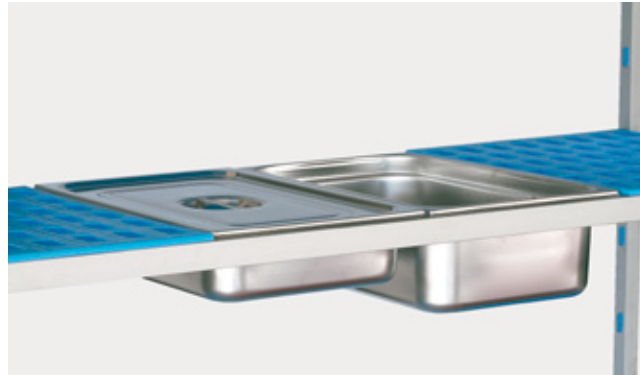

Compatible with 2/3 containers  
Compatible con cubetas 2/3  
Compatible avec bacs 2/3

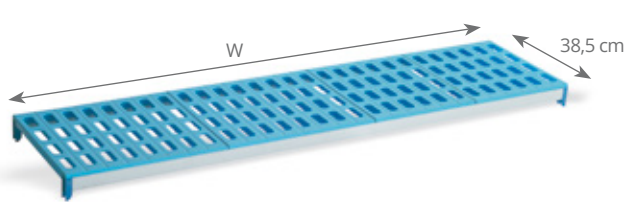

Compatible with 1/1 containers  
Compatible con cubetas 1/1  
Compatible avec bacs 1/1

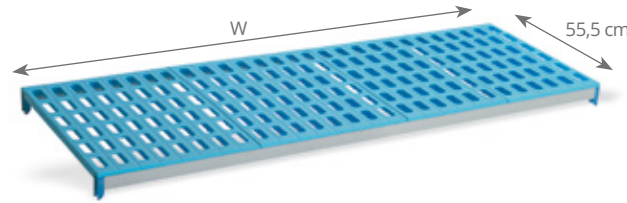

REF	W cm	🛒/📦
P7047	71,5	1/1
P7048	83,0	1/1
P7049	93,5	1/1
P7050	104,5	1/1
P7051	115,5	1/1
P7052	126,3	1/1
P7053	137,5	1/1
P7054	148,0	1/1
P7055	159,0	1/1
P7056	170,5	1/1
P7057	184,0	1/1
P7058	195,0	1/1
P7059	206,0	1/1
P7060	217,0	1/1
P7061	228,0	1/1
P7062	238,8	1/1
P7063	249,6	1/1
P7064	260,8	1/1
P7065	272,0	1/1
P7066	282,5	1/1
P7067	293,0	1/1
P7068	304,0	1/1
P7069	315,0	1/1
P7070	326,5	1/1

REF	W cm	🛒/📦
P7071	338,0	1/1
P7072	351,3	1/1
P7073	362,1	1/1
P7074	372,9	1/1
P7075	384,1	1/1
P7076	395,3	1/1
P7077	406,5	1/1
P7078	417,0	1/1
P7079	427,5	1/1
P7080	438,0	1/1
P7081	449,0	1/1
P7082	460,0	1/1
P7083	471,0	1/1
P7084	482,5	1/1
P7085	494,0	1/1
P7086	505,5	1/1
P7087	518,6	1/1
P7088	529,8	1/1
P7089	541,0	1/1
P7090	551,5	1/1
P7091	562,0	1/1
P7092	572,5	1/1
P7093	583,0	1/1

REF	W cm	🛒/📦
P7188	71,5	1/1
P7189	83,0	1/1
P7190	93,5	1/1
P7191	104,5	1/1
P7192	115,5	1/1
P7193	126,3	1/1
P7194	137,5	1/1
P7195	148,0	1/1
P7196	159,0	1/1
P7197	170,5	1/1
P7198	184,0	1/1
P7199	195,0	1/1
P7200	206,0	1/1
P7201	217,0	1/1
P7202	228,0	1/1
P7203	238,8	1/1
P7204	249,6	1/1
P7205	260,8	1/1
P7206	272,0	1/1
P7207	282,5	1/1
P7208	293,0	1/1
P7209	304,0	1/1
P7210	315,0	1/1
P7211	326,5	1/1

REF	W cm	🛒/📦
P7212	338,0	1/1
P7213	351,3	1/1
P7214	362,1	1/1
P7215	372,9	1/1
P7216	384,1	1/1
P7217	395,3	1/1
P7218	406,5	1/1
P7219	417,0	1/1
P7220	427,5	1/1
P7221	438,0	1/1
P7222	449,0	1/1
P7223	460,0	1/1
P7224	471,0	1/1
P7225	482,5	1/1
P7226	494,0	1/1
P7227	505,5	1/1
P7228	518,6	1/1
P7229	529,8	1/1
P7230	541,0	1/1
P7231	551,5	1/1
P7232	562,0	1/1
P7233	572,5	1/1
P7234	583,0	1/1

**IDEA!** For others heights, see the table (p. 324-327)  
Para otras alturas, consultar el desglose (p. 324-327)  
Pour autres hauteurs, consulter le tableau de décomposition (p. 324-327)

# Shelving for angle 11.1

Estantería angular / Rayonnage angulaire

**4 Levels**  
Niveles  
Niveaux

**Shelvings for angle**  
Estanterías angulares  
Rayonnages angulaires

**Diferent combinations**  
Distintas combinaciones  
Differentes combinaisons



**Included / Incluido / Compris:**  
Hooks to form angles  
Ganchos para formar ángulos  
Crochets pour faire les angles

Compatible with 2/3 containers  
Compatible con cubetas 2/3  
Compatible avec bacs 2/3

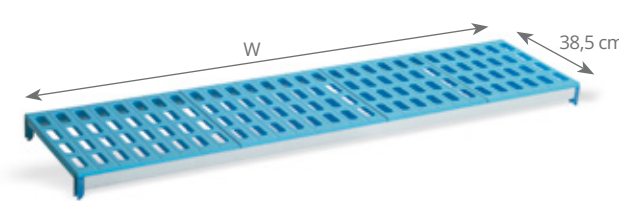

Compatible with 1/1 containers  
Compatible con cubetas 1/1  
Compatible avec bacs 1/1

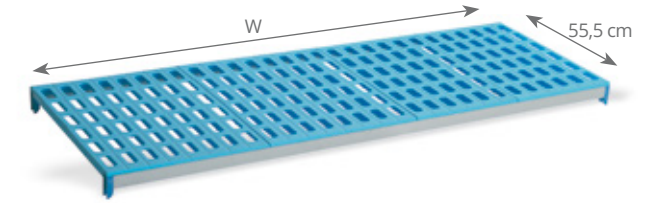

REF	W cm	🛒/📦
P7329	68,5	1/1
P7330	80,0	1/1
P7331	90,5	1/1
P7332	101,5	1/1
P7333	112,5	1/1
P7334	123,3	1/1
P7335	134,5	1/1
P7336	145,0	1/1
P7337	156,0	1/1
P7338	167,5	1/1
P7339	181,0	1/1
P7340	192,0	1/1
P7341	203,0	1/1
P7342	214,0	1/1
P7343	225,0	1/1
P7344	235,8	1/1
P7345	246,6	1/1
P7346	257,8	1/1
P7347	269,0	1/1
P7348	279,5	1/1
P7349	290,0	1/1
P7350	301,0	1/1
P7351	312,0	1/1
P7352	323,5	1/1

REF	W cm	🛒/📦
P7353	335,0	1/1
P7354	348,3	1/1
P7355	359,1	1/1
P7356	369,9	1/1
P7357	381,1	1/1
P7358	392,3	1/1
P7359	403,5	1/1
P7360	414,0	1/1
P7361	424,5	1/1
P7362	435,0	1/1
P7363	446,0	1/1
P7364	457,0	1/1
P7365	468,0	1/1
P7366	479,5	1/1
P7367	491,0	1/1
P7368	502,5	1/1
P7369	515,6	1/1
P7370	526,8	1/1
P7371	538,0	1/1
P7372	548,5	1/1
P7373	559,0	1/1
P7374	569,5	1/1
P7375	580,0	1/1

REF	W cm	🛒/📦
P7470	68,5	1/1
P7471	80,0	1/1
P7472	90,5	1/1
P7473	101,5	1/1
P7474	112,5	1/1
P7475	123,3	1/1
P7476	134,5	1/1
P7477	145,0	1/1
P7478	156,0	1/1
P7479	167,5	1/1
P7480	181,0	1/1
P7481	192,0	1/1
P7482	203,0	1/1
P7483	214,0	1/1
P7484	225,0	1/1
P7485	235,8	1/1
P7486	246,6	1/1
P7487	257,8	1/1
P7488	269,0	1/1
P7489	279,5	1/1
P7490	290,0	1/1
P7491	301,0	1/1
P7492	312,0	1/1
P7493	323,5	1/1

REF	W cm	🛒/📦
P7494	335,0	1/1
P7495	348,3	1/1
P7496	359,1	1/1
P7497	369,9	1/1
P7498	381,1	1/1
P7499	392,3	1/1
P7500	403,5	1/1
P7501	414,0	1/1
P7502	424,5	1/1
P7503	435,0	1/1
P7504	446,0	1/1
P7505	457,0	1/1
P7506	468,0	1/1
P7507	479,5	1/1
P7508	491,0	1/1
P7509	502,5	1/1
P7510	515,6	1/1
P7511	526,8	1/1
P7512	538,0	1/1
P7513	548,5	1/1
P7514	559,0	1/1
P7515	569,5	1/1
P7516	580,0	1/1

**IDEA!** For others heights, see the table (p. 324-327)  
Para otras alturas, consultar el desglose (p. 324-327)  
Pour autres hauteurs, consulter le tableau de décomposition (p. 324-327)

# 11.1 Full shelf

Estantería completa / Rayonnage complet

**5 Levels**  
Niveles  
Niveaux

**Complete kits**  
Kits completos  
Kits complets

**Diferent combinations**  
Distintas combinaciones  
Diferentes combinaisons

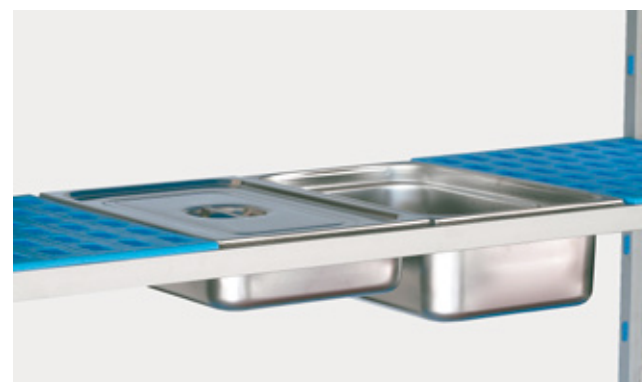

**Compatible with 2/3 containers**  
Compatible con cubetas 2/3  
Compatible avec bacs 2/3

**Compatible with 1/1 containers**  
Compatible con cubetas 1/1  
Compatible avec bacs 1/1

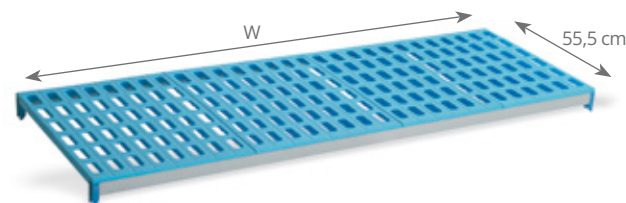
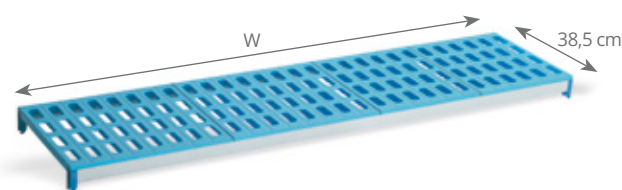

REF	W cm	🛒/📦
P7094	71,5	1/1
P7095	83,0	1/1
P7096	93,5	1/1
P7097	104,5	1/1
P7098	115,5	1/1
P7099	126,3	1/1
P7100	137,5	1/1
P7101	148,0	1/1
P7102	159,0	1/1
P7103	170,5	1/1
P7104	184,0	1/1
P7105	195,0	1/1
P7106	206,0	1/1
P7107	217,0	1/1
P7108	228,0	1/1
P7109	238,8	1/1
P7110	249,6	1/1
P7111	260,8	1/1
P7112	272,0	1/1
P7113	282,5	1/1
P7114	293,0	1/1
P7115	304,0	1/1
P7116	315,0	1/1
P7117	326,5	1/1

REF	W cm	🛒/📦
P7118	338,0	1/1
P7119	351,3	1/1
P7120	362,1	1/1
P7121	372,9	1/1
P7122	384,1	1/1
P7123	395,3	1/1
P7124	406,5	1/1
P7125	417,0	1/1
P7126	427,5	1/1
P7127	438,0	1/1
P7128	449,0	1/1
P7129	460,0	1/1
P7130	471,0	1/1
P7131	482,5	1/1
P7132	494,0	1/1
P7133	505,5	1/1
P7134	518,6	1/1
P7135	529,8	1/1
P7136	541,0	1/1
P7137	551,5	1/1
P7138	562,0	1/1
P7139	572,5	1/1
P7140	583,0	1/1

REF	W cm	🛒/📦
P7235	71,5	1/1
P7236	83,0	1/1
P7237	93,5	1/1
P7238	104,5	1/1
P7239	115,5	1/1
P7240	126,3	1/1
P7241	137,5	1/1
P7242	148,0	1/1
P7243	159,0	1/1
P7244	170,5	1/1
P7245	184,0	1/1
P7246	195,0	1/1
P7247	206,0	1/1
P7248	217,0	1/1
P7249	228,0	1/1
P7250	238,8	1/1
P7251	249,6	1/1
P7252	260,8	1/1
P7253	272,0	1/1
P7254	282,5	1/1
P7255	293,0	1/1
P7256	304,0	1/1
P7257	315,0	1/1
P7258	326,5	1/1

REF	W cm	🛒/📦
P7259	338,0	1/1
P7260	351,3	1/1
P7261	362,1	1/1
P7262	372,9	1/1
P7263	384,1	1/1
P7264	395,3	1/1
P7265	406,5	1/1
P7266	417,0	1/1
P7267	427,5	1/1
P7268	438,0	1/1
P7269	449,0	1/1
P7270	460,0	1/1
P7271	471,0	1/1
P7272	482,5	1/1
P7273	494,0	1/1
P7274	505,5	1/1
P7275	518,6	1/1
P7276	529,8	1/1
P7277	541,0	1/1
P7278	551,5	1/1
P7279	562,0	1/1
P7280	572,5	1/1
P7281	583,0	1/1

**5 Levels**  
Niveles  
Niveaux

**Shelvings for angle**  
Estanterías angulares  
Rayonnages angulaires

**Diferent combinations**  
Distintas combinaciones  
Diferentes combinaisons

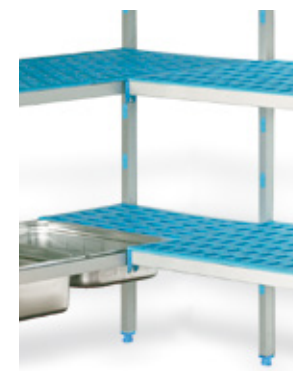

**Included / Incluido / Compris :**  
**Hooks to form angles**  
Ganchos para formar ángulos  
Crochets pour faire les angles



**Compatible with 2/3 containers**  
Compatible con cubetas 2/3  
Compatible avec bacs 2/3

**Compatible with 1/1 containers**  
Compatible con cubetas 1/1  
Compatible avec bacs 1/1

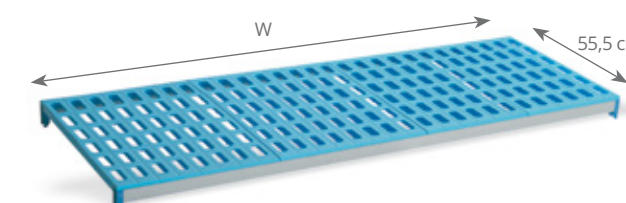
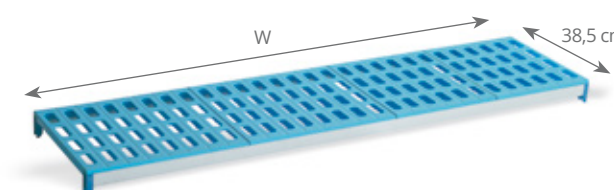

REF	W cm	🛒/📦
P7376	68,5	1/1
P7377	80,0	1/1
P7378	90,5	1/1
P7379	101,5	1/1
P7380	112,5	1/1
P7381	123,3	1/1
P7382	134,5	1/1
P7383	145,0	1/1
P7384	156,0	1/1
P7385	167,5	1/1
P7386	181,0	1/1
P7387	192,0	1/1
P7388	203,0	1/1
P7389	214,0	1/1
P7390	225,0	1/1
P7391	235,8	1/1
P7392	246,6	1/1
P7393	257,8	1/1
P7394	269,0	1/1
P7395	279,5	1/1
P7396	290,0	1/1
P7397	301,0	1/1
P7398	312,0	1/1
P7399	323,5	1/1

REF	W cm	🛒/📦
P7400	335,0	1/1
P7401	348,3	1/1
P7402	359,1	1/1
P7403	369,9	1/1
P7404	381,1	1/1
P7405	392,3	1/1
P7406	403,5	1/1
P7407	414,0	1/1
P7408	424,5	1/1
P7409	435,0	1/1
P7410	446,0	1/1
P7411	457,0	1/1
P7412	468,0	1/1
P7413	479,5	1/1
P7414	491,0	1/1
P7415	502,5	1/1
P7416	515,6	1/1
P7417	526,8	1/1
P7418	538,0	1/1
P7419	548,5	1/1
P7420	559,0	1/1
P7421	569,5	1/1
P7422	580,0	1/1

REF	W cm	🛒/📦
P7517	68,5	1/1
P7518	80,0	1/1
P7519	90,5	1/1
P7520	101,5	1/1
P7521	112,5	1/1
P7522	123,3	1/1
P7523	134,5	1/1
P7524	145,0	1/1
P7525	156,0	1/1
P7526	167,5	1/1
P7527	181,0	1/1
P7528	192,0	1/1
P7529	203,0	1/1
P7530	214,0	1/1
P7531	225,0	1/1
P7532	235,8	1/1
P7533	246,6	1/1
P7534	257,8	1/1
P7535	269,0	1/1
P7536	279,5	1/1
P7537	290,0	1/1
P7538	301,0	1/1
P7539	312,0	1/1
P7540	323,5	1/1

REF	W cm	🛒/📦
P7541	335,0	1/1
P7542	348,3	1/1
P7543	359,1	1/1
P7544	369,9	1/1
P7545	381,1	1/1
P7546	392,3	1/1
P7547	403,5	1/1
P7548	414,0	1/1
P7549	424,5	1/1
P7550	435,0	1/1
P7551	446,0	1/1
P7552	457,0	1/1
P7553	468,0	1/1
P7554	479,5	1/1
P7555	491,0	1/1
P7556	502,5	1/1
P7557	515,6	1/1
P7558	526,8	1/1
P7559	538,0	1/1
P7560	548,5	1/1
P7561	559,0	1/1
P7562	569,5	1/1
P7563	580,0	1/1

**IDEA!** For others heights, see the table (p. 324-327)  
Para otras alturas, consultar el desglose (p. 324-327)  
Pour autres hauteurs, consulter le tableau de décomposition (p. 324-327)

**IDEA!** For others heights, see the table (p. 324-327)  
Para otras alturas, consultar el desglose (p. 324-327)  
Pour autres hauteurs, consulter le tableau de décomposition (p. 324-327)

## 11.2 Shelving with casters

Estanterías con ruedas / Rayonnages avec roues

**Complete kits with casters**  
Conjuntos completos con ruedas  
Kits complets avec roues

 **Maximum weight per level 150 kg**  
**Maximum weight per shelving unit 400 kg**

Peso máximo por nivel 150 kg  
Peso máximo por estantería 400 kg  
Poids maximum par niveau 150 kg  
Poids maximum par rayonnage 400 kg



REF	W x D x H cm	Type tipo	Levels Niveles Niveaux	
P7145R	114,5 x 55,5 x 188	GN 1/1	3	1/1
P7004R	114,5 x 38,5 x 188	GN 2/3	3	1/1
P7146R	126,5 x 55,5 x 188	GN 1/1	3	1/1
P7005R	126,5 x 38,5 x 188	GN 2/3	3	1/1
P7147R	137,5 x 55,5 x 188	GN 1/1	3	1/1
P7006R	137,5 x 38,5 x 188	GN 2/3	3	1/1

## 11.3 Bench

Bancadas  
Bancs

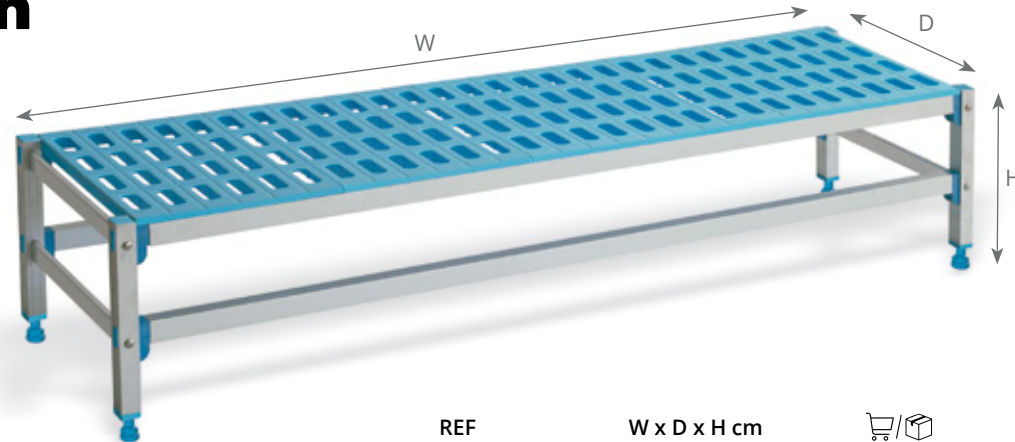

Designed to be used in places where it is forbidden to put boxes directly on the floor. Maximum load charge 175 Kg per bench, distributed weight throughout the bench. Leveling feet for gradient floors.

Diseñadas para su uso en lugares donde se prohíbe depositar cajas directamente en el suelo. Capacidad de carga de hasta 175 Kg por bancada, repartidos a lo largo de la bancada. Pie regulable para suelos desnivelados.

Conçus pour être utilisés quand il est interdit de poser les boîtes directement par terre. Charge maximale 175 Kg, distribués tout au long du banc. Pieds réglables pour sols irréguliers.

REF	W x D x H cm	
P7603	71,5 x 55,5 x 28	1/1
P7604	83,0 x 55,5 x 28	1/1
P7605	93,5 x 55,5 x 28	1/1
P7606	104,5 x 55,5 x 28	1/1
P7607	115,5 x 55,5 x 28	1/1
P7608	126,5 x 55,5 x 28	1/1
P7609	137,5 x 55,5 x 28	1/1
P7610	148,0 x 55,5 x 28	1/1
P7611	71,5 x 38,5 x 28	1/1
P7612	83,0 x 38,5 x 28	1/1
P7613	93,5 x 38,5 x 28	1/1
P7614	104,5 x 38,5 x 28	1/1
P7615	115,5 x 38,5 x 28	1/1
P7616	126,5 x 38,5 x 28	1/1
P7617	137,5 x 38,5 x 28	1/1
P7618	148,0 x 38,5 x 28	1/1

## Parts 11.4

Componentes / Composants

**Shelf support fixing**  
Soporte fijación estantería  
Support fixation rayonnage



**Two pieces kit**  
Conjunto de 2 soportes  
Kit deux pièces

REF	
P76430	1/1

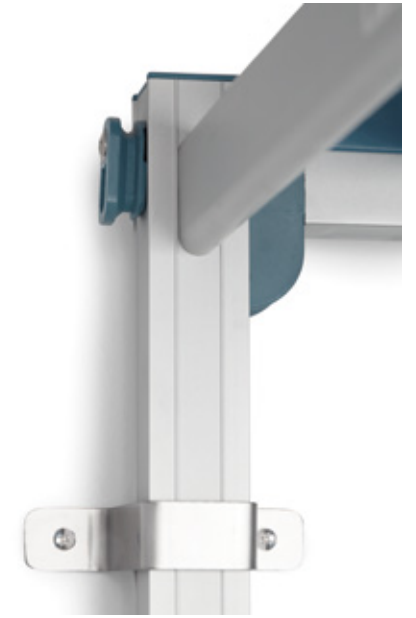



**Crossbars**  
Travesaños  
Longerons

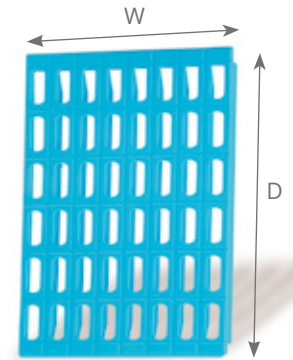

REF	W cm	
P7632	65,5	1/1
P7633	77,0	1/1
P7634	87,5	1/1
P7635	98,5	1/1
P7636	109,5	1/1
P7637	120,5	1/1
P7638	131,5	1/1
P7639	142,0	1/1
P7640	153,0	1/1
P7641	164,5	1/1

**Rack-shelves**  
Parrillas  
Clayettes



REF	Type / Tipo	W x D cm	GN For / Para / Pour	
P7628	Y	55,5 x 43,5	1/1	1/1
P7629	X	55,5 x 32,5	1/1	1/1
P7630	Y	38,5 x 43,5	2/3	1/1
P7631	X	38,5 x 32,5	2/3	1/1

**Hooks to form angles**  
Ganchos para formar ángulos  
Crochets pour faire les angles



REF	
P7642	1/1

**Support for crossbars**  
Pieza soporte para travesaños  
Support pour longerons

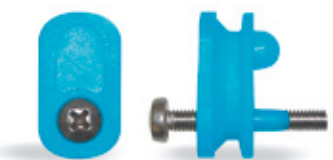

REF	
P7643	1/1

# 11.4 Parts

Componentes / Composants

## Lateral supports

Soportes laterales  
Suports latéraux



## Lateral support with casters

Soportes laterales con ruedas  
Suports latéraux avec roues



2 Available depths:  
55,5 cm, 1/1 gastronorm  
38,5 cm, 2/3 gastronorm

2 Fondos disponibles :  
55,5 cm, gastronorm 1/1  
38,5 cm, gastronorm 2/3

2 profondeurs disponibles:  
55,5 cm, gastronorm 1/1  
38,5 cm, gastronorm 2/3

### To assembly mobile shelving with casters.

Para montar estanterías móviles con ruedas.  
Pour monter rayonnages mobiles avec roues.

### Casters Ø 12,5 cm, two of them with brake.

Ruedas de Ø 12,5 cm, dos de ellas con freno.  
Roues de Ø 12,5 cm, dont deux avec frein.

### We do not recommend crossbars longer than 140 cm.

No se recomiendan longitudes de travesaños superiores a 140 cm.  
Nous ne conseillons pas des longerons plus longs de 140 cm.

REF	MOD	D x H cm	Levels Niveles Niveaux	
P7585	S1	55,5 x 175	3	1/1
P7586	S2	55,5 x 175	4	1/1
P7587	S3	55,5 x 175	5	1/1
P7646	S0	55,5 x 200	4	1/1
P7588	S4	55,5 x 200	5	1/1
P7589	S5	55,5 x 200	6	1/1
P7590	S6	55,5 x 130	3	1/1
P7591	S7	38,5 x 175	3	1/1
P7592	S8	38,5 x 175	4	1/1
P7593	S9	38,5 x 175	5	1/1
P7647	S13	38,5 x 200	4	1/1
P7594	S10	38,5 x 200	5	1/1
P7595	S11	38,5 x 200	6	1/1
P7596	S12	38,5 x 130	3	1/1

REF	D x H cm	Levels Niveles Niveaux	
P7597	55,5 x 188*	3	1/1
P7598	55,5 x 188*	4	1/1
P7599	55,5 x 188*	5	1/1
NEW P7600	38,5 x 188*	3	1/1
NEW P7601	38,5 x 188*	4	1/1
NEW P7602	38,5 x 188*	5	1/1

\* Height including caster / Altura con rueda incluida / Hauteur avec la roue incluse.

# Parts 11.4

Componentes / Composants

## Shelves depth 38,5 cm

Estantes fondo 38,5 cm  
Niveaux profondeur 38,5 cm

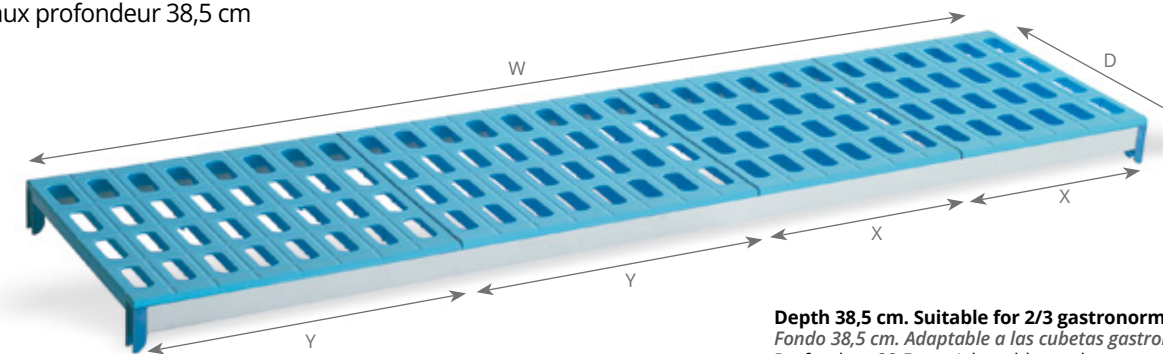

Depth 38,5 cm. Suitable for 2/3 gastronorm containers  
Fondo 38,5 cm. Adaptable a las cubetas gastronorm 2/3  
Profondeur 38,5 cm. Adaptable aux bacs gastronorm 2/3

X is a rack 32,5 cm width.  
Y is a rack 43,5 cm width.

X significa una parrilla de ancho 32,5 cm.  
Y significa una parrilla de ancho 43,5 cm.  
X est une clayette de 32,5 cm de largeur.  
Y est une clayette de 43,5 cm de largeur.

REF	MOD	Combination Combinación Combinaison	W x D cm	
P7575	T61	X + X	65,5 x 38,5	1/1
P7576	T71	X + Y	77,0 x 38,5	1/1
P7577	T81	Y + Y	87,5 x 38,5	1/1
P7578	T91	X + X + X	98,5 x 38,5	1/1
P7579	T101	Y + X + X	109,5 x 38,5	1/1
P7580	T111	Y + Y + X	120,5 x 38,5	1/1
P7581	T131	Y + Y + Y	131,5 x 38,5	1/1
P7582	T141	Y + X + X + X	142,0 x 38,5	1/1
P7583	T151	Y + Y + X + X	153,0 x 38,5	1/1
P7584	T161	Y + Y + Y + X	164,5 x 38,5	1/1

## Shelves depth 55,5 cm

Estantes fondo 55,5 cm  
Niveaux profondeur 55,5 cm

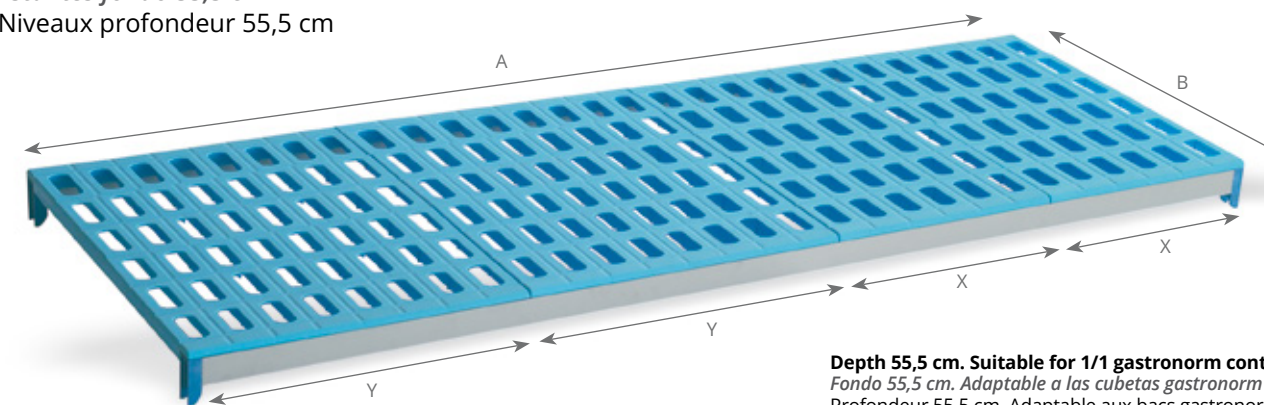

Depth 55,5 cm. Suitable for 1/1 gastronorm containers  
Fondo 55,5 cm. Adaptable a las cubetas gastronorm 1/1  
Profondeur 55,5 cm. Adaptable aux bacs gastronorm 1/1

X is a rack 32,5 cm width.  
Y is a rack 43,5 cm width.

X significa una parrilla de ancho 32,5 cm.  
Y significa una parrilla de ancho 43,5 cm.  
X est une clayette de 32,5 cm de largeur.  
Y est une clayette de 43,5 cm de largeur.

REF	MOD	Combination Combinación Combinaison	W x D cm	
P7565	T6	X + X	65,5 x 55,5	1/1
P7566	T7	X + Y	77,0 x 55,5	1/1
P7567	T8	Y + Y	87,5 x 55,5	1/1
P7568	T9	X + X + X	98,5 x 55,5	1/1
P7569	T10	Y + X + X	109,5 x 55,5	1/1
P7570	T11	Y + Y + X	120,5 x 55,5	1/1
P7571	T13	Y + Y + Y	131,5 x 55,5	1/1
P7572	T14	Y + X + X + X	142,0 x 55,5	1/1
P7573	T15	Y + Y + X + X	153,0 x 55,5	1/1
P7574	T16	Y + Y + Y + X	164,5 x 55,5	1/1

# 11.5 Breakdown of shelving sets

Desglose conjuntos de estanterías / Décomposition kits rayonnages

## DEPTH 38,5 cm. Suitable for 2/3 GASTRONORM

FONDO 38,5 cm. Adaptable a GASTRONORM 2/3

PROFONDEUR 38,5 cm. Adaptable aux GASTRONORME 2/3

REF. 3 levels 3 niveles 3 niveaux	Breakdown Desglose Décomposition	REF. 4 levels 4 niveles 4 niveaux	Breakdown Desglose Décomposition	REF. 5 levels 5 niveles 5 niveaux	Breakdown Desglose Décomposition
P7000	2 S7 + 3 T61	P7047	2 S8 + 4 T61	P7094	2 S9 + 5 T61
P7001	2 S7 + 3 T71	P7048	2 S8 + 4 T71	P7095	2 S9 + 5 T71
P7002	2 S7 + 3 T81	P7049	2 S8 + 4 T81	P7096	2 S9 + 5 T81
P7003	2 S7 + 3 T91	P7050	2 S8 + 4 T91	P7097	2 S9 + 5 T91
P7004	2 S7 + 3 T101	P7051	2 S8 + 4 T101	P7098	2 S9 + 5 T101
P7005	2 S7 + 3 T111	P7052	2 S8 + 4 T111	P7099	2 S9 + 5 T111
P7006	2 S7 + 3 T131	P7053	2 S8 + 4 T131	P7100	2 S9 + 5 T131
P7007	2 S7 + 3 T141	P7054	2 S8 + 4 T141	P7101	2 S9 + 5 T141
P7008	2 S7 + 3 T151	P7055	2 S8 + 4 T151	P7102	2 S9 + 5 T151
P7009	2 S7 + 3 T161	P7056	2 S8 + 4 T161	P7103	2 S9 + 5 T161
P7010	3 S7 + 6 T81	P7057	3 S8 + 8 T81	P7104	3 S9 + 10 T81
P7011	3 S7 + 3 T81 + 3 T91	P7058	3 S8 + 4 T81 + 4 T91	P7105	3 S9 + 5 T81 + 5 T91
P7012	3 S7 + 6 T91	P7059	3 S8 + 8 T91	P7106	3 S9 + 10 T91
P7013	3 S7 + 3 T91 + 3 T101	P7060	3 S8 + 4 T91 + 4 T101	P7107	3 S9 + 5 T91 + 5 T101
P7014	3 S7 + 6 T101	P7061	3 S8 + 8 T101	P7108	3 S9 + 10 T101
P7015	3 S7 + 3 T101 + 3 T111	P7062	3 S8 + 4 T101 + 4 T111	P7109	3 S9 + 5 T101 + 5 T111
P7016	3 S7 + 6 T111	P7063	3 S8 + 8 T111	P7110	3 S9 + 10 T111
P7017	3 S7 + 3 T111 + 3 T131	P7064	3 S8 + 4 T111 + 4 T131	P7111	3 S9 + 5 T111 + 5 T131
P7018	3 S7 + 6 T131	P7065	3 S8 + 8 T131	P7112	3 S9 + 10 T131
P7019	3 S7 + 3 T131 + 3 T141	P7066	3 S8 + 4 T131 + 4 T141	P7113	3 S9 + 5 T131 + 5 T141
P7020	3 S7 + 6 T141	P7067	3 S8 + 8 T141	P7114	3 S9 + 10 T141
P7021	3 S7 + 3 T141 + 3 T151	P7068	3 S8 + 4 T141 + 4 T151	P7115	3 S9 + 5 T141 + 5 T151
P7022	3 S7 + 6 T151	P7069	3 S8 + 8 T151	P7116	3 S9 + 10 T151
P7023	3 S7 + 3 T151 + 3 T161	P7070	3 S8 + 4 T151 + 4 T161	P7117	3 S9 + 5 T151 + 5 T161
P7024	3 S7 + 6 T161	P7071	3 S8 + 8 T161	P7118	3 S9 + 10 T161
P7025	4 S7 + 6 T101 + 3 T111	P7072	4 S8 + 8 T101 + 4 T111	P7119	4 S9 + 10 T101 + 3 T111
P7026	4 S7 + 3 T101 + 6 T111	P7073	4 S8 + 4 T101 + 8 T111	P7120	4 S9 + 5 T101 + 10 T111
P7027	4 S7 + 9 T111	P7074	4 S8 + 12 T111	P7121	4 S9 + 15 T111
P7028	4 S7 + 6 T111 + 3 T131	P7075	4 S8 + 8 T111 + 4 T131	P7122	4 S9 + 10 T111 + 5 T131
P7029	4 S7 + 3 T111 + 6 T131	P7076	4 S8 + 4 T111 + 8 T131	P7123	4 S9 + 5 T111 + 10 T131
P7030	4 S7 + 9 T131	P7077	4 S8 + 12 T131	P7124	4 S9 + 15 T131
P7031	4 S7 + 6 T131 + 3 T141	P7078	4 S8 + 8 T131 + 4 T141	P7125	4 S9 + 10 T131 + 5 T141
P7032	4 S7 + 3 T131 + 6 T141	P7079	4 S8 + 4 T131 + 8 T141	P7126	4 S9 + 5 T131 + 10 T141
P7033	4 S7 + 9 T141	P7080	4 S8 + 12 T141	P7127	4 S9 + 15 T141
P7034	4 S7 + 6 T141 + 3 T151	P7081	4 S8 + 8 T141 + 4 T151	P7128	4 S9 + 10 T141 + 5 T151
P7035	4 S7 + 3 T141 + 6 T151	P7082	4 S8 + 4 T141 + 8 T151	P7129	4 S9 + 5 T141 + 10 T151
P7036	4 S7 + 9 T151	P7083	4 S8 + 12 T151	P7130	4 S9 + 15 T151
P7037	4 S7 + 6 T151 + 3 T161	P7084	4 S8 + 8 T151 + 4 T161	P7131	4 S9 + 10 T151 + 5 T161
P7038	4 S7 + 3 T151 + 6 T161	P7085	4 S8 + 4 T151 + 8 T161	P7132	4 S9 + 5 T151 + 10 T161
P7039	4 S7 + 9 T161	P7086	4 S8 + 12 T161	P7133	4 S9 + 15 T161
P7040	5 S7 + 6 T111 + 6 T131	P7087	5 S8 + 8 T111 + 8 T131	P7134	5 S9 + 10 T111 + 10 T131
P7041	5 S7 + 3 T111 + 9 T131	P7088	5 S8 + 4 T111 + 12 T131	P7135	5 S9 + 5 T111 + 15 T131
P7042	5 S7 + 12 T131	P7089	5 S8 + 16 T131	P7136	5 S9 + 20 T131
P7043	5 S7 + 3 T141 + 9 T131	P7090	5 S8 + 4 T141 + 12 T131	P7137	5 S9 + 5 T141 + 15 T131
P7044	5 S7 + 6 T131 + 6 T141	P7091	5 S8 + 8 T131 + 8 T141	P7138	5 S9 + 10 T131 + 10 T141
P7045	5 S7 + 3 T131 + 9 T141	P7092	5 S8 + 4 T131 + 12 T141	P7139	5 S9 + 5 T131 + 15 T141
P7046	5 S7 + 12 T141	P7093	5 S8 + 16 T141	P7140	5 S9 + 20 T141

# Breakdown of shelving sets 11.5

Desglose conjuntos de estanterías / Décomposition kits rayonnages

## DEPTH 55,5 cm. Suitable for 1/1 GASTRONORM

FONDO 55,5 cm. Adaptable a GASTRONORM 1/1

PROFONDEUR 55,5 cm. Adaptable aux GASTRONORME 1/1

REF. 3 levels 3 niveles 3 niveaux	Breakdown Desglose Décomposition	REF. 4 levels 4 niveles 4 niveaux	Breakdown Desglose Décomposition	REF. 5 levels 5 niveles 5 niveaux	Breakdown Desglose Décomposition
P7141	2 S1 + 3 T6	P7188	2 S2 + 4 T6	P7235	2 S3 + 5 T6
P7142	2 S1 + 3 T7	P7189	2 S2 + 4 T7	P7236	2 S3 + 5 T7
P7143	2 S1 + 3 T8	P7190	2 S2 + 4 T8	P7237	2 S3 + 5 T8
P7144	2 S1 + 3 T9	P7191	2 S2 + 4 T9	P7238	2 S3 + 5 T9
P7145	2 S1 + 3 T10	P7192	2 S2 + 4 T10	P7239	2 S3 + 5 T10
P7146	2 S1 + 3 T11	P7193	2 S2 + 4 T11	P7240	2 S3 + 5 T11
P7147	2 S1 + 3 T13	P7194	2 S2 + 4 T13	P7241	2 S3 + 5 T13
P7148	2 S1 + 3 T14	P7195	2 S2 + 4 T14	P7242	2 S3 + 5 T14
P7149	2 S1 + 3 T15	P7196	2 S2 + 4 T15	P7243	2 S3 + 5 T15
P7150	2 S1 + 3 T16	P7197	2 S2 + 4 T16	P7244	2 S3 + 5 T16
P7151	3 S1 + 6 T8	P7198	3 S2 + 8 T8	P7245	3 S3 + 10 T8
P7152	3 S1 + 3 T8 + 3 T9	P7199	3 S2 + 4 T8 + 4 T9	P7246	3 S3 + 5 T8 + 5 T9
P7153	3 S1 + 6 T9	P7200	3 S2 + 8 T9	P7247	3 S3 + 10 T9
P7154	3 S1 + 3 T9 + 3 T10	P7201	3 S2 + 4 T9 + 4 T10	P7248	3 S3 + 5 T9 + 5 T10
P7155	3 S1 + 6 T10	P7202	3 S2 + 8 T10	P7249	3 S3 + 10 T10
P7156	3 S1 + 3 T10 + 3 T11	P7203	3 S2 + 4 T10 + 4 T11	P7250	3 S3 + 5 T10 + 5 T11
P7157	3 S1 + 6 T11	P7204	3 S2 + 8 T11	P7251	3 S3 + 10 T11
P7158	3 S1 + 3 T11 + 3 T13	P7205	3 S2 + 4 T11 + 4 T13	P7252	3 S3 + 5 T11 + 5 T13
P7159	3 S1 + 6 T13	P7206	3 S2 + 8 T13	P7253	3 S3 + 10 T13
P7160	3 S1 + 3 T13 + 3 T14	P7207	3 S2 + 4 T13 + 4 T14	P7254	3 S3 + 5 T13 + 5 T14
P7161	3 S1 + 6 T14	P7208	3 S2 + 8 T14	P7255	3 S3 + 10 T14
P7162	3 S1 + 3 T14 + 3 T15	P7209	3 S2 + 4 T14 + 4 T15	P7256	3 S3 + 5 T14 + 5 T15
P7163	3 S1 + 6 T15	P7210	3 S2 + 8 T15	P7257	3 S3 + 10 T15
P7164	3 S1 + 3 T15 + 3 T16	P7211	3 S2 + 4 T15 + 4 T16	P7258	3 S3 + 5 T15 + 5 T16
P7165	3 S1 + 6 T16	P7212	3 S2 + 8 T16	P7259	3 S3 + 10 T16
P7166	4 S1 + 6 T10 + 3 T11	P7213	4 S2 + 8 T10 + 4 T11	P7260	4 S3 + 10 T10 + 5 T11
P7167	4 S1 + 3 T10 + 6 T11	P7214	4 S2 + 4 T10 + 8 T11	P7261	4 S3 + 5 T10 + 10 T11
P7168	4 S1 + 9 T11	P7215	4 S2 + 12 T11	P7262	4 S3 + 15 T11
P7169	4 S1 + 6 T11 + 3 T13	P7216	4 S2 + 8 T11 + 4 T13	P7263	4 S3 + 10 T11 + 5 T13
P7170	4 S1 + 3 T11 + 6 T13	P7217	4 S2 + 4 T11 + 8 T13	P7264	4 S3 + 5 T11 + 10 T13
P7171	4 S1 + 9 T13	P7218	4 S2 + 12 T13	P7265	4 S3 + 15 T13
P7172	4 S1 + 6 T13 + 3 T14	P7219	4 S2 + 8 T13 + 4 T14	P7266	4 S3 + 10 T13 + 5 T14
P7173	4 S1 + 3 T13 + 6 T14	P7220	4 S2 + 4 T13 + 8 T14	P7267	4 S3 + 5 T13 + 10 T14
P7174	4 S1 + 9 T14	P7221	4 S2 + 12 T14	P7268	4 S3 + 15 T14
P7175	4 S1 + 6 T14 + 3 T15	P7222	4 S2 + 8 T14 + 4 T15	P7269	4 S3 + 10 T14 + 5 T15
P7176	4 S1 + 3 T14 + 6 T15	P7223	4 S2 + 4 T14 + 8 T15	P7270	4 S3 + 5 T14 + 10 T15
P7177	4 S1 + 9 T15	P7224	4 S2 + 12 T15	P7271	4 S3 + 15 T15
P7178	4 S1 + 6 T15 + 3 T16	P7225	4 S2 + 8 T15 + 4 T16	P7272	4 S3 + 10 T15 + 5 T16
P7179	4 S1 + 3 T15 + 6 T16	P7226	4 S2 + 4 T15 + 8 T16	P7273	4 S3 + 5 T15 + 10 T16
P7180	4 S1 + 9 T16	P7227	4 S2 + 12 T16	P7274	4 S3 + 15 T16
P7181	5 S1 + 6 T11 + 6 T13	P7228	5 S2 + 8 T11 + 8 T13	P7275	5 S3 + 10 T11 + 10 T13
P7182	5 S1 + 3 T11 + 9 T13	P7229	5 S2 + 4 T11 + 12 T13	P7276	5 S3 + 5 T11 + 15 T13
P7183	5 S1 + 12 T13	P7230	5 S2 + 16 T13	P7277	5 S3 + 20 T13
P7184	5 S1 + 3 T14 + 9 T13	P7231	5 S2 + 4 T14 + 12 T13	P7278	5 S3 + 5 T14 + 15 T13
P7185	5 S1 + 6 T13 + 6 T14	P7232	5 S2 + 8 T13 + 8 T14	P7279	5 S3 + 10 T13 + 10 T14
P7186	5 S1 + 3 T13 + 9 T14	P7233	5 S2 + 4 T13 + 12 T14	P7280	5 S3 + 5 T13 + 15 T14
P7187	5 S1 + 12 T14	P7234	5 S2 + 16 T14	P7281	5 S3 + 20 T14

# 11.5 Breakdown of shelving sets

Desglose conjuntos de estanterías / Décomposition kits rayonnages

## DEPTH 38,5 cm. Suitable for 2/3 GASTRONORM

FONDO 38,5 cm. Adaptable a GASTRONORM 2/3

PROFONDEUR 38,5 cm. Adaptable aux GASTRONORME 2/3

REF. 3 levels 3 niveles 3 niveaux	Breakdown Desglose Décomposition	REF. 4 levels 4 niveles 4 niveaux	Breakdown Desglose Décomposition	REF. 5 levels 5 niveles 5 niveaux	Breakdown Desglose Décomposition
P7282	1 S7 + 3 T61	P7329	1 S8 + 4 T61	P7376	1 S9 + 5 T61
P7283	1 S7 + 3 T71	P7330	1 S8 + 4 T71	P7377	1 S9 + 5 T71
P7284	1 S7 + 3 T81	P7331	1 S8 + 4 T81	P7378	1 S9 + 5 T81
P7285	1 S7 + 3 T91	P7332	1 S8 + 4 T91	P7379	1 S9 + 5 T91
P7286	1 S7 + 3 T101	P7333	1 S8 + 4 T101	P7380	1 S9 + 5 T101
P7287	1 S7 + 3 T111	P7334	1 S8 + 4 T111	P7381	1 S9 + 5 T111
P7288	1 S7 + 3 T131	P7335	1 S8 + 4 T131	P7382	1 S9 + 5 T131
P7289	1 S7 + 3 T141	P7336	1 S8 + 4 T141	P7383	1 S9 + 5 T141
P7290	1 S7 + 3 T151	P7337	1 S8 + 4 T151	P7384	1 S9 + 5 T151
P7291	1 S7 + 3 T161	P7338	1 S8 + 4 T161	P7385	1 S9 + 5 T161
P7292	2 S7 + 6 T81	P7339	2 S8 + 8 T81	P7386	2 S9 + 10 T81
P7293	2 S7 + 3 T81 + 3 T91	P7340	2 S8 + 4 T81 + 4 T91	P7387	2 S9 + 5 T81 + 5 T91
P7294	2 S7 + 6 T91	P7341	2 S8 + 8 T91	P7388	2 S9 + 10 T91
P7295	2 S7 + 3 T91 + 3 T101	P7342	2 S8 + 4 T91 + 4 T101	P7389	2 S9 + 5 T91 + 5 T101
P7296	2 S7 + 6 T101	P7343	2 S8 + 8 T101	P7390	2 S9 + 10 T101
P7297	2 S7 + 3 T111 + 3 T111	P7344	2 S8 + 4 T101 + 4 T111	P7391	2 S9 + 5 T101 + 5 T111
P7298	2 S7 + 6 T111	P7345	2 S8 + 8 T111	P7392	2 S9 + 10 T111
P7299	2 S7 + 3 T111 + 3 T131	P7346	2 S8 + 4 T111 + 4 T131	P7393	2 S9 + 5 T111 + 5 T131
P7300	2 S7 + 6 T131	P7347	2 S8 + 8 T131	P7394	2 S9 + 10 T131
P7301	2 S7 + 3 T131 + 3 T141	P7348	2 S8 + 4 T131 + 4 T141	P7395	2 S9 + 5 T131 + 5 T141
P7302	2 S7 + 6 T141	P7349	2 S8 + 8 T141	P7396	2 S9 + 10 T141
P7303	2 S7 + 3 T141 + 3 T151	P7350	2 S8 + 4 T141 + 4 T151	P7397	2 S9 + 5 T141 + 5 T151
P7304	2 S7 + 6 T151	P7351	2 S8 + 8 T151	P7398	2 S9 + 10 T151
P7305	2 S7 + 3 T151 + 3 T161	P7352	2 S8 + 4 T151 + 4 T161	P7399	2 S9 + 5 T151 + 5 T161
P7306	2 S7 + 6 T161	P7353	2 S8 + 8 T161	P7400	2 S9 + 10 T161
P7307	3 S7 + 6 T101 + 3 T111	P7354	3 S8 + 8 T101 + 4 T111	P7401	3 S9 + 10 T101 + 3 T111
P7308	3 S7 + 3 T101 + 6 T111	P7355	3 S8 + 4 T101 + 8 T111	P7402	3 S9 + 5 T101 + 10 T111
P7309	3 S7 + 9 T111	P7356	3 S8 + 12 T111	P7403	3 S9 + 15 T111
P7310	3 S7 + 6 T111 + 3 T131	P7357	3 S8 + 8 T111 + 4 T131	P7404	3 S9 + 10 T111 + 5 T131
P7311	3 S7 + 3 T111 + 6 T131	P7358	3 S8 + 4 T111 + 8 T131	P7405	3 S9 + 5 T111 + 10 T131
P7312	3 S7 + 9 T131	P7359	3 S8 + 12 T131	P7406	3 S9 + 15 T131
P7313	3 S7 + 6 T131 + 3 T141	P7360	3 S8 + 8 T131 + 4 T141	P7407	3 S9 + 10 T131 + 5 T141
P7314	3 S7 + 3 T131 + 6 T141	P7361	3 S8 + 4 T131 + 8 T141	P7408	3 S9 + 5 T131 + 10 T141
P7315	3 S7 + 9 T141	P7362	3 S8 + 12 T141	P7409	3 S9 + 15 T141
P7316	3 S7 + 6 T141 + 3 T151	P7363	3 S8 + 8 T141 + 4 T151	P7410	3 S9 + 10 T141 + 5 T151
P7317	3 S7 + 3 T141 + 6 T151	P7364	3 S8 + 4 T141 + 8 T151	P7411	3 S9 + 5 T141 + 10 T151
P7318	3 S7 + 9 T151	P7365	3 S8 + 12 T151	P7412	3 S9 + 15 T151
P7319	3 S7 + 6 T151 + 3 T161	P7366	3 S8 + 8 T151 + 4 T161	P7413	3 S9 + 10 T151 + 5 T161
P7320	3 S7 + 3 T151 + 6 T161	P7367	3 S8 + 4 T151 + 8 T161	P7414	3 S9 + 5 T151 + 10 T161
P7321	3 S7 + 9 T161	P7368	3 S8 + 12 T161	P7415	3 S9 + 15 T161
P7322	4 S7 + 6 T111 + 6 T131	P7369	4 S8 + 8 T111 + 8 T131	P7416	4 S9 + 10 T111 + 10 T131
P7323	4 S7 + 3 T111 + 9 T131	P7370	4 S8 + 4 T111 + 12 T131	P7417	4 S9 + 5 T111 + 15 T131
P7324	4 S7 + 12 T131	P7371	4 S8 + 16 T131	P7418	4 S9 + 20 T131
P7325	4 S7 + 3 T141 + 9 T131	P7372	4 S8 + 4 T141 + 12 T131	P7419	4 S9 + 5 T141 + 15 T131
P7326	4 S7 + 6 T131 + 6 T141	P7373	4 S8 + 8 T131 + 8 T141	P7420	4 S9 + 10 T131 + 10 T141
P7327	4 S7 + 3 T131 + 9 T141	P7374	4 S8 + 4 T131 + 12 T141	P7421	4 S9 + 5 T131 + 15 T141
P7328	4 S7 + 12 T141	P7375	4 S8 + 16 T141	P7422	4 S9 + 20 T141

# Breakdown of shelving sets 11.5

Desglose conjuntos de estanterías / Décomposition kits rayonnages

## DEPTH 55,5 cm. Suitable for 1/1 GASTRONORM

FONDO 55,5 cm. Adaptable a GASTRONORM 1/1

PROFONDEUR 55,5 cm. Adaptable aux GASTRONORME 1/1

REF. 3 levels 3 niveles 3 niveaux	Breakdown Desglose Décomposition	REF. 4 levels 4 niveles 4 niveaux	Breakdown Desglose Décomposition	REF. 5 levels 5 niveles 5 niveaux	Breakdown Desglose Décomposition
P7423	1 S1 + 3 T6	P7470	1 S2 + 4 T6	P7517	1 S3 + 5 T6
P7424	1 S1 + 3 T7	P7471	1 S2 + 4 T7	P7518	1 S3 + 5 T7
P7425	1 S1 + 3 T8	P7472	1 S2 + 4 T8	P7519	1 S3 + 5 T8
P7426	1 S1 + 3 T9	P7473	1 S2 + 4 T9	P7520	1 S3 + 5 T9
P7427	1 S1 + 3 T10	P7474	1 S2 + 4 T10	P7521	1 S3 + 5 T10
P7428	1 S1 + 3 T11	P7475	1 S2 + 4 T11	P7522	1 S3 + 5 T11
P7429	1 S1 + 3 T13	P7476	1 S2 + 4 T13	P7523	1 S3 + 5 T13
P7430	1 S1 + 3 T14	P7477	1 S2 + 4 T14	P7524	1 S3 + 5 T14
P7431	1 S1 + 3 T15	P7478	1 S2 + 4 T15	P7525	1 S3 + 5 T15
P7432	1 S1 + 3 T16	P7479	1 S2 + 4 T16	P7526	1 S3 + 5 T16
P7433	2 S1 + 6 T8	P7480	2 S2 + 8 T8	P7527	2 S3 + 10 T8
P7434	2 S1 + 3 T8 + 3 T9	P7481	2 S2 + 4 T8 + 4 T9	P7528	2 S3 + 5 T8 + 5 T9
P7435	2 S1 + 6 T9	P7482	2 S2 + 8 T9	P7529	2 S3 + 10 T9
P7436	2 S1 + 3 T9 + 3 T10	P7483	2 S2 + 4 T9 + 4 T10	P7530	2 S3 + 5 T9 + 5 T10
P7437	2 S1 + 6 T10	P7484	2 S2 + 8 T10	P7531	2 S3 + 10 T10
P7438	2 S1 + 3 T10 + 3 T11	P7485	2 S2 + 4 T10 + 4 T11	P7532	2 S3 + 5 T10 + 5 T11
P7439	2 S1 + 6 T11	P7486	2 S2 + 8 T11	P7533	2 S3 + 10 T11
P7440	2 S1 + 3 T11 + 3 T13	P7487	2 S2 + 4 T11 + 4 T13	P7534	2 S3 + 5 T11 + 5 T13
P7441	2 S1 + 6 T13	P7488	2 S2 + 8 T13	P7535	2 S3 + 10 T13
P7442	2 S1 + 3 T13 + 3 T14	P7489	2 S2 + 4 T13 + 4 T14	P7536	2 S3 + 5 T13 + 5 T14
P7443	2 S1 + 6 T14	P7490	2 S2 + 8 T14	P7537	2 S3 + 10 T14
P7444	2 S1 + 3 T14 + 3 T15	P7491	2 S2 + 4 T14 + 4 T15	P7538	2 S3 + 5 T14 + 5 T15
P7445	2 S1 + 6 T15	P7492	2 S2 + 8 T15	P7539	2 S3 + 10 T15
P7446	2 S1 + 3 T15 + 3 T16	P7493	2 S2 + 4 T15 + 4 T16	P7540	2 S3 + 5 T15 + 5 T16
P7447	2 S1 + 6 T16	P7494	2 S2 + 8 T16	P7541	2 S3 + 10 T16
P7448	3 S1 + 6 T10 + 3 T11	P7495	3 S2 + 8 T10 + 4 T11	P7542	3 S3 + 10 T10 + 5 T11
P7449	3 S1 + 3 T10 + 6 T11	P7496	3 S2 + 4 T10 + 8 T11	P7543	3 S3 + 5 T10 + 10 T11
P7450	3 S1 + 9 T11	P7497	3 S2 + 12 T11	P7544	3 S3 + 15 T11
P7451	3 S1 + 6 T11 + 3 T13	P7498	3 S2 + 8 T11 + 4 T13	P7545	3 S3 + 10 T11 + 5 T13
P7452	3 S1 + 3 T11 + 6 T13	P7499	3 S2 + 4 T11 + 8 T13	P7546	3 S3 + 5 T11 + 10 T13
P7453	3 S1 + 9 T13	P7500	3 S2 + 12 T13	P7547	3 S3 + 15 T13
P7454	3 S1 + 6 T13 + 3 T14	P7501	3 S2 + 8 T13 + 4 T14	P7548	3 S3 + 10 T13 + 5 T14
P7455	3 S1 + 3 T13 + 6 T14	P7502	3 S2 + 4 T13 + 8 T14	P7549	3 S3 + 5 T13 + 10 T14
P7456	3 S1 + 9 T14	P7503	3 S2 + 12 T14	P7550	3 S3 + 15 T14
P7457	3 S1 + 6 T14 + 3 T15	P7504	3 S2 + 8 T14 + 4 T15	P7551	3 S3 + 10 T14 + 5 T15
P7458	3 S1 + 3 T14 + 6 T15	P7505	3 S2 + 4 T14 + 8 T15	P7552	3 S3 + 5 T14 + 10 T15
P7459	3 S1 + 9 T15	P7506	3 S2 + 12 T15	P7553	3 S3 + 15 T15
P7460	3 S1 + 6 T15 + 3 T16	P7507	3 S2 + 8 T15 + 4 T16	P7554	3 S3 + 10 T15 + 5 T16
P7461	3 S1 + 3 T15 + 6 T16	P7508	3 S2 + 4 T15 + 8 T16	P7555	3 S3 + 5 T15 + 10 T16
P7462	3 S1 + 9 T16	P7509	3 S2 + 12 T16	P7556	3 S3 + 15 T16
P7463	4 S1 + 6 T11 + 6 T13	P7510	4 S2 + 8 T11 + 8 T13	P7557	4 S3 + 10 T11 + 10 T13
P7464	4 S1 + 3 T11 + 9 T13	P7511	4 S2 + 4 T11 + 12 T13	P7558	4 S3 + 5 T11 + 15 T13
P7465	4 S1 + 12 T13	P7512	4 S2 + 16 T13	P7559	4 S3 + 20 T13
P7466	4 S1 + 3 T14 + 9 T13	P7513	4 S2 + 4 T14 + 12 T13	P7560	4 S3 + 5 T14 + 15 T13
P7467	4 S1 + 6 T13 + 6 T14	P7514	4 S2 + 8 T13 + 8 T14	P7561	4 S3 + 10 T13 + 10 T14
P7468	4 S1 + 3 T13 + 9 T14	P7515	4 S2 + 4 T13 + 12 T14	P7562	4 S3 + 5 T13 + 15 T14
P7469	4 S1 + 12 T14	P7516	4 S2 + 16 T14	P7563	4 S3 + 20 T14