

14 Buffet & accessories

Buffet y accesorios

Buffet et accessoires



14.1	BUFFET TROLLEYS	438
	<i>CARROS BUFFET / CHARRIOT BUFFET</i>	
14.2	DISPLAY STANDS & BASKETS	444
	<i>PRESENTACIÓN Y EXPOSITORES</i>	
	<i>PRÉSENTOIRS ET PRÉSENTOIRS CORBEILLES</i>	
14.3	BUFFET COOKWARE	458
	<i>BATERIAS PARA BUFFET / BUFFET CUISINE</i>	
	Cool line collection	458
	Bronze collection	462
	Miramar® collection	464
14.4	SUPER SHAPES	470
	BUFFET PRESENTATION STEAM TABLE PANS	
	<i>CUBETAS PRESENTACIÓN BUFFET / BACS PRÉSENTATION BUFFET</i>	
14.5	CUBIC	472
14.6	CHAFERS & DISPENSERS	488
	<i>CHAFINGS Y DISPENSADORES / CHAFERS ET DISTRIBUTEURS</i>	
14.7	PROTECTION & COVERS	498
	<i>PROTECCIÓN Y TAPAS / PROTECTION ET COUVERCLES</i>	
14.8	BOWLS & SERVING TRAYS	500
	<i>BOLS & BANDEJAS DE SERVICIO / BOLS & PLATEAUX</i>	
14.9	SERVING TOOLS	503
	<i>UTENSILIOS DE SERVICIO / USTENSILES DE SERVICE BUFFET</i>	
14.10	SIGNS	512
	<i>SEÑALIZACIÓN / SIGNALIZATION</i>	

BUFFET TROLLEYS

Design your own space



14.1 BUFFET TROLLEYS

by **pujadas**

Wo
Wood

CS
Carbon steel

Easy to assemble thanks to a tool-free anchoring system

Fácil de montar gracias a su sistema de anclaje sin herramientas

Facile à monter grâce à un système d'ancrage sans outils

Handle included with all carts. A second one can be added.

Tirador incluido en todos los carros. Se puede añadir otro.

Poignée incluse avec tous les chariots. Une deuxième peut être ajoutée.

Revolving casters, 2 with brakes

Ruedas giratorias, 2 con freno

Roues pivotantes, 2 avec frein

Multiple shelves and compartments compatible with GN sizes

Múltiples estantes y espacios compatibles con medidas GN

Multiplés étagères et espaces compatibles avec les dimensions GN

Central shelves designed for flat or inclined display

Estantes centrales diseñados para presentación en plano o inclinados

Étagères centrales conçues pour une présentation à plat ou inclinée

Premium materials and high-quality finishes:

- Tubular structure in black matte-finished carbon steel.
- Solid wood tabletop with a Formica coating resistant to heat, humidity, and wear.

Materiales premium y acabados de alta calidad:

- Estructura tubular de acero al carbono acabado negro mate.
- Tablero de madera maciza con recubrimiento de fórmica resistente al calor, la humedad y el desgaste.

Matériaux haut de gamme et des finitions de haute qualité :

- Structure tubulaire en acier au carbone avec finition noire mate.
- Plateau en bois massif avec revêtement en Formica résistant à la chaleur, à l'humidité et à l'usure.

NEW

Two-height adjustable panel

Panel ajustable a dos alturas

Panneau réglable à deux hauteurs

Bottle holder integrated into the handle

Botellero integrado en el tirador

Porte-bouteilles intégré à la poignée

Buffet trolleys 14.1

Carros buffet / Chariot buffet

NEW

Versatile, with multiple work and storage areas. Adaptable to any type of space or event.

Versátil, con múltiples espacios de trabajo y almacenaje. Adaptable a cualquier tipo de espacio o evento.

Polyvalent, avec multiples zones de travail et de rangement, Adaptable à tout type d'espace ou d'événement.

Buffet trolley with top module

Carro buffet con módulo superior

Chariot buffet avec module supérieur

Buffet trolley

Carro buffet

Chariot buffet



2 wire baskets GN 1/1 included.
2 cestas metálicas GN 1/1 incluidas.
2 paniers métalliques GN 1/1 inclus.

REF	W x D x H cm	🛒/📦
P90950	124 x 50 x 88	1/1



2 wire baskets GN 1/1 & 3 wooden boxes GN 1/2 included.
2 cestas metálicas GN 1/1 y 3 cajas de madera GN 1/2 incluidas.
2 paniers métalliques GN 1/1 et 3 caisses en bois GN 1/2 inclus.

REF	W x D x H cm	🛒/📦
P90940	124 x 50 x 150	1/1

DESIGN YOUR OWN SPACE / Diseña tu propio espacio / Concevez votre propre espace



14.1 Buffet trolleys

Carros buffet / Chariot buffet

NEW

Wo Wood CS Carbon steel

Two-level serving trolley wooden top

Carro de servicio dos niveles encimera madera
Chariot service à deux niveaux plateau en bois



REF	W x D x H cm	Shopping icon
P90960	90 x 50 x 88	1/1

Three-level serving trolley wooden top

Carro de servicio tres niveles encimera madera
Chariot service à trois niveaux plateau en bois



REF	W x D x H cm	Shopping icon
P90961	90 x 50 x 88	1/1

Three-level serving trolley wooden top

Carro de servicio tres niveles encimera madera
Chariot service à trois niveaux plateau en bois



REF	W x D x H cm	Shopping icon
P90962	90 x 50 x 88	1/1

Three-level serving trolley wooden top

Carro de servicio tres niveles encimera madera
Chariot service à trois niveaux plateau en bois



Inclined middle shelf / Estante central inclinado / Étagère centrale inclinée.

REF	W x D x H cm	Shopping icon
P90963	90 x 50 x 88	1/1

Wo Wood CS Carbon steel

NEW

Three-level serving trolley wooden top

Carro de servicio tres niveles encimera madera
Chariot service à trois niveaux plateau en bois



2 inclined shelves
2 estantes inclinados
2 étagères inclinées

REF	W x D x H cm	Shopping icon
P90964	90 x 50 x 88	1/1

Shelf
Estante
Étagère



REF	W x D x H cm	Shopping icon
P90980	90 x 50 x 4	1/1

Handle
Tirador
Poignée

CS Carbon steel



REF	W x D x H cm	Shopping icon
P90971	50 x 13 x 2	1/1

Buffet trolleys 14.1

Carros buffet / Chariot buffet

See products on
Ver productos en / Voir produits en page

P. 446

Wooden box GN 1/1 and 1/2

Caja de madera GN 1/1 y 1/2
Caisse en bois GN 1/1 et 1/2



Corner shelf
Estante esquinero
Étagère d'angle



Maximum load 20 kg
Carga máxima 20 kg
Charge maximale 20 kg

REF	W x D x H cm	Shopping icon
P90981	50 x 50 x 4	1/1

Bottle rack
Botellero
Porte-bouteilles

CS Carbon steel



Inserts into the handle
Se inserta en el tirador
S'insère dans la poignée

REF	W x D x H cm	Shopping icon
P90970	48 x 10,5 x 10	1/1

14.2 Display stands & baskets

Presentación y expositores / Présentoirs et présentoirs corbeilles

Nova

Induction warming station

Estación inducción mantenedora

Station induction maintien de température

NEW



Induction unit, temperature control knob and wooden frame included.
Incluye placa de inducción, mando control de temperatura y marco de madera.
Comprend une plaque à induction, un contrôleur de température et un cadre en bois.

REF	V	W	Hz	🗑️	🛒
P595026	220-240	1000	50/60	EU	1/1

Serving tray

Bandeja de servicio

Plateau service

NEW



Reversible
Réversible

Suitable for: / Compatibles con: / Adaptable pour: P595050

REF	W x D x H cm	🗑️	🛒
P595024	62 x 42 x 7	1/1	

Tray stand

Soporte para bandeja

Support plateau

NEW



Suitable for:
Compatibles con:
Adaptable pour:
P595024

REF	W x D x H cm	🗑️	🛒
P595050	42 x 36 x 81,5	1/1	

Display stands & baskets 14.2

Presentación y expositores / Présentoirs et présentoirs corbeilles



Nova



Small wooden box

Caja pequeña de madera

Petite boîte en bois



Stackable
Apilable
Empilable

REF	W x D x H cm	🗑️	🛒
P595005	17,5 x 17 x 12,5	1/1	

Large wooden box

Caja grande de madera

Grande boîte en bois



Stackable
Apilable
Empilable

REF	W x D x H cm	🗑️	🛒
P595006	17,5 x 31 x 12,5	1/1	

Large double wooden box

Caja grande doble de madera

Grande boîte double en bois



Stackable
Apilable
Empilable

REF	W x D x H cm	🗑️	🛒
P595007	35 x 31 x 12,5	1/1	

14.2 Display stands & baskets

Presentación y expositores / Présentoirs et présentoirs corbeilles



NEW

Flat display stand GN
Expositor metálico recto GN
Présentoir métallique droit GN

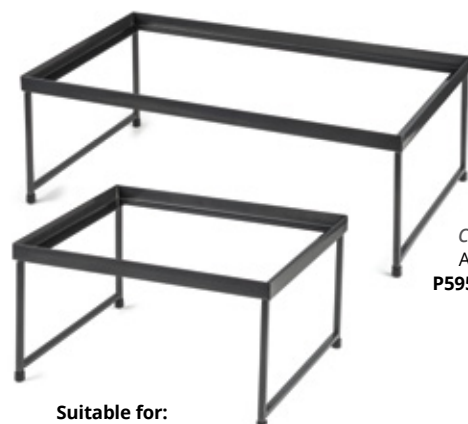

Suitable for:
Compatibles con:
Adaptable pour:
P595015, P595016.

REF	W x D x H cm	GN	
P598004	55,5 x 35 x 20	1/1	1/1
P598005	34,5 x 29 x 20	1/2	1/1

Angled display stand GN
Expositor metálico inclinado GN
Présentoir métallique incliné GN



Suitable for:
Compatibles con:
Adaptable pour:
P595015, P595016.

REF	W x D x H cm	GN	
P598006	55,5 x 35 x 15	1/1	1/1
P598007	34,5 x 29 x 15	1/2	1/1

Wooden box GN 1/1
Caja de madera GN 1/1
Caisse en bois GN 1/1



Stackable
Apilable
Empilable



Suitable for display boards and pans GN 1/1.
Compatibles con soportes de presentación y cubetas GN 1/1.
Adaptable pour présentoirs and bacs GN 1/1.

REF	W x D x H cm	
P595013	54,5 x 34 x 6	1/1
P595014	54,5 x 34 x 9	1/1

Wooden box GN 1/2
Caja de madera GN 1/2
Caisse en bois GN 1/2



Stackable
Apilable
Empilable



Suitable for display boards and pans GN 1/2.
Compatibles con soportes de presentación y cubetas GN 1/2.
Adaptable pour présentoirs and bacs GN 1/2.

REF	W x D x H cm	
P595015	34 x 28 x 6	1/1
P595016	34 x 28 x 9	1/1

Display stands & baskets 14.2

Presentación y expositores / Présentoirs et présentoirs corbeilles

Wooden box GN 1/3
Caja de madera GN 1/3
Caisse en bois GN 1/3

NEW



Stackable
Apilable
Empilable



Suitable for display boards and pans GN 1/3.
Compatibles con soportes de presentación y cubetas GN 1/3.
Adaptable pour présentoirs and bacs GN 1/3.

REF	W x D x H cm	
P595021	34 x 19 x 6	1/1

Wooden box GN 2/4
Caja de madera GN 2/4
Caisse en bois GN 2/4

NEW



Stackable
Apilable
Empilable



Suitable for display boards and pans GN 2/4.
Compatibles con soportes de presentación y cubetas GN 12/4.
Adaptable pour présentoirs and bacs GN 1/4.

REF	W x D x H cm	
P595020	54,5 x 18 x 6	1/1

Display board
Soporte presentación
Présentoir



1/1 2/4



REF	GN	W x D x H cm	
P22680	1/1	53 x 32,5 x 2	1/3
P22681	1/2	32,5 x 26,5 x 2	1/3
P22682	1/3	32,5 x 17,6 x 2	1/3
P22683	2/4	53 x 16,2 x 2	1/6

Suitable for
Compatible con / Adaptable pour

P. 429



P. 461



P. 425



P. 426

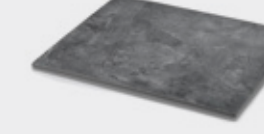

14.2 Display stands & baskets

Presentación y expositores / Présentoirs et présentoirs corbeilles



Nova



dishwasher

Cutlery-holder tray
Bandeja porta-cubiertos
Plateau porte-couverts



4 Compartments
4 Compartimentos
4 Compartiments

With non-slip feet
Con pies antideslizantes
Avec pieds antidérapants

REF	W x D x H cm	
P595009	54 x 33,5 x 9,5	1/1

Cutlery-holder box
Caja para cubiertos
Caisse porte-couverts



NEW

Stackable
Apilable
Empilable

REF	W x D x H cm	
P595022	28 x 15 x 7	1/1

Cutting board
Tabla de cortar
Planche à découper



With non-slip feet
Con pies antideslizantes
Avec pieds antidérapants

REF	W x D x H cm	
P595008	48 x 32 x 2	1/1

Serving tray
Bandeja de servicio
Plateau service



Stackable
Apilable
Empilable

REF	W x D x H cm	
P595012	45 x 35 x 6	1/1

Display stands & baskets 14.2

Presentación y expositores / Présentoirs et présentoirs corbeilles



dishwasher

Nova



Wooden shelf
Estante de madera
Tablette en bois



REF	W x D x H cm	
P595010	100 x 25 x 2,5	1/1
P595011	70 x 25 x 2,5	1/1

Wooden bowl
Bol de madera
Bol en bois



REF	Ø cm	H cm	
P595017	30	12,5	1/5

Wooden bowl
Bol de madera
Bol en bois



REF	W x D x H cm	
P595019	30 x 30 x 12	1/4

Suitable for
Compatible con / Adaptable pour

P. 456

Buffet stand
Soporte para buffet
Présentoir buffet

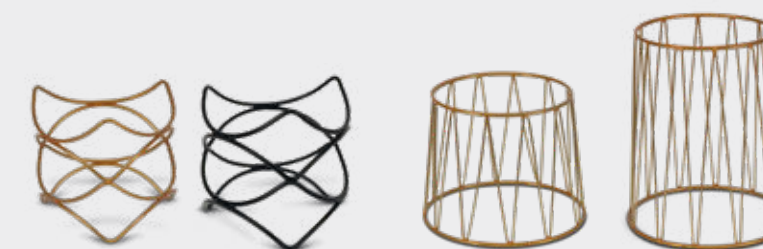

14.2 Display stands & baskets

Presentación y expositores / Présentoirs et présentoirs corbeilles



One tier flat display stand

Expositor metálico recto de un nivel
Présentoir métallique droit à un niveau



Baskets not included
Cestas no incluidas
Panniers non inclus



REF	W x D x H cm	Shopping icons
P598001	45 x 30 x 20,5	1/8

One tier angled display stand

Expositor metálico inclinado de un nivel
Présentoir métallique incliné à un niveau



Baskets not included
Cestas no incluidas
Panniers non inclus



REF	W x D x H cm	Shopping icons
P598002	45 x 30 x 14,5	1/8

Three tier flat display stand

Expositor metálico recto de 3 niveles
Présentoir métallique droit 3 niveaux



Baskets not included
Cestas no incluidas
Panniers non inclus



REF	W x D x H cm	Shopping icons
P598003	30 x 24 x 51,5	1/2

Display stands & baskets 14.2

Presentación y expositores / Présentoirs et présentoirs corbeilles

Rectangular metal wire basket

Cesta metálica rectangular
Panier métallique rectangulaire



Suitable for
Combinable con
Adaptable pour
P598001 / P598002



REF	W x D x H cm	Shopping icons
P591006	45 x 30 x 5	1/12

Rectangular metal wire basket

Cesta metálica rectangular
Panier métallique rectangulaire



Suitable for
Combinable con
Adaptable pour
P598003



REF	W x D x H cm	Shopping icons
P591007	30 x 22,5 x 5	1/12

Wooden box

Caja de madera
Caisse en bois



dishwasher

Suitable for
Combinable con
Adaptable pour
P598001 / P598002

Stackable
Apilables
Empilables



REF	W x D x H cm	Shopping icons
P595001	45 x 30 x 5	1/6
P595002	45 x 30 x 10	1/4

Wooden box

Caja de madera
Caisse en bois



dishwasher

Suitable for
Combinable con
Adaptable pour
P598003

Stackable
Apilables
Empilables



REF	W x D x H cm	Shopping icons
P595003	30 x 22,5 x 5	1/12
P595004	30 x 22,5 x 10	1/8

14.2 Display stands & baskets

Presentación y expositores / Présentoirs et présentoirs corbeilles



Black GN wire basket
Cesta rejilla GN negra
Pannier métallique GN noir

Black GN wire basket
Cesta rejilla GN negra
Pannier métallique GN noir



1/1

REF	Mod	W x D x H cm	🛒/📦
P596110	1/1	52 x 31,5 x 12	1/6
P596111	1/1	52 x 31,5 x 16	1/6



1/2

REF	Mod	W x D x H cm	🛒/📦
P596120	1/2	31,5 x 25,5 x 12	1/6
P596121	1/2	31,5 x 25,5 x 16	1/6

Black GN wire basket
Cesta rejilla GN negra
Pannier métallique GN noir



1/3

REF	Mod	W x D x H cm	🛒/📦
P596130	1/3	31,5 x 17 x 12	1/6
P596131	1/3	31,5 x 17 x 16	1/6

Suitable for
Compatible con / Adaptable pour



P. 426



P. 427



P. 425

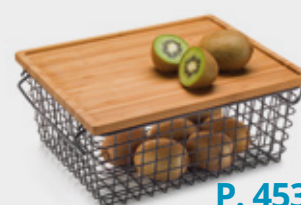

P. 453



dishwasher

NATURAL
FIBERS

Display stands & baskets 14.2

Presentación y expositores / Présentoirs et présentoirs corbeilles



Dos posiciones: derecho y revés.
Two positions: right and reverse.
Deux positions: droit et envers
Zwei Positionen: rechts und rückwärts.

GN buffet bamboo box
Caja GN bambú buffet
Présentoir GN buffet bambou

GN buffet bamboo box
Caja GN bambú buffet
Présentoir GN buffet bambou



1/1

REF	Mod	H cm	🛒/📦
P595110	1/1	10	1/1
P595111	1/1	20	1/1



1/2

REF	Mod	H cm	🛒/📦
P595120	1/2	10	1/1
P595121	1/2	20	1/1

GN buffet bamboo box
Caja GN bambú buffet
Présentoir GN buffet bambou

Tray - Lid for GN buffet bamboo box
Bandeja - Tapa para caja GN bambú buffet
Plateau - Couvercle pour présentoir GN buffet bambou



1/3

REF	Mod	H cm	🛒/📦
P595130	1/3	10	1/1
P595131	1/3	20	1/1



REF	Mod	H cm	🛒/📦
P595100	1/1	2	1/3
P595200	1/2	2	1/4
P595300	1/3	2	1/6

Suitable for
Compatible con / Adaptable pour



P. 425

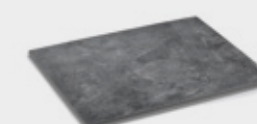

P. 426



P. 429



P. 499

14.2 Display stands & baskets

Presentación y expositores / Présentoirs et présentoirs corbeilles

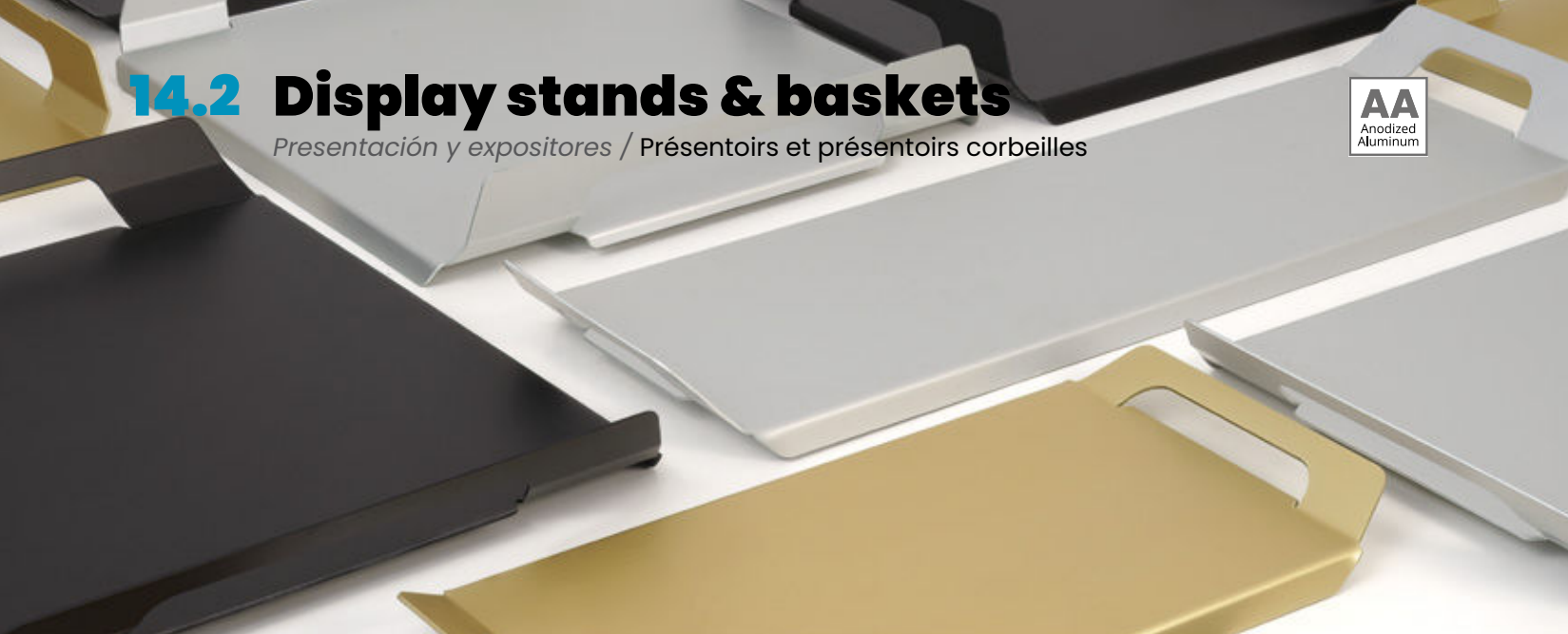

Available in 3 colours: black, silver and gold in a matt finish.

Stackable.

Suitable for food contact.

Double functionality: tray and riser.

Made from 2 mm thick anodised aluminium providing great strength and toughness.

Disponibles en 3 colores: negro, plata y dorado en acabado mate.

Apilables.

Apta para contacto alimentario.

Doble funcionalidad: bandeja y riser.

Realizado en aluminio adonizado de 2 mm de grosor que ofrece gran robustez y resistencia.

Disponibles en 3 couleurs : noir, argent et doré en finition mate.

Empilables.

Adapté au contact alimentaire.

Double fonctionnalité : plateau et riser.

Fabriqué en aluminium anodisé de 2 mm d'épaisseur, ce qui lui confère une grande robustesse et une grande résistance.

GN 1/1 buffet tray
Bandeja buffet GN 1/1
Plateau buffet GN 1/1

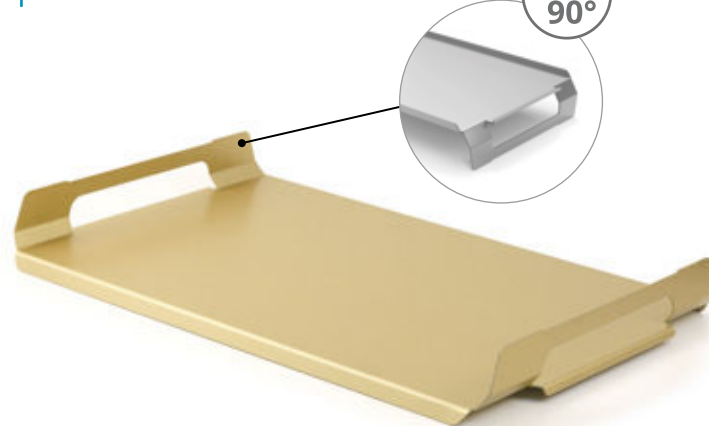

Ref. colour / Ref. color / Ref. couleur couvercle



IDEA! P317500B / P317500S / P317500G
Adaptable to GN 1/1 trolleys and food transport boxes with guides.
Adaptables a carros GN 1/1 y cajas de transporte de alimentos con guías.
Adaptables aux chariots GN 1/1 et aux caisses de transport de nourriture avec guides.

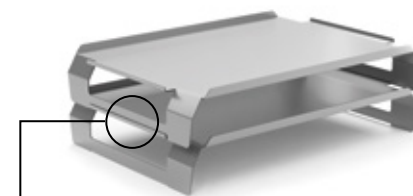

Click on the top of the handle to stack the trays stable and secure.

Encaje en la parte superior del asa para apilar las bandejas de forma estable y segura.

Enclenchez le dessus de la poignée pour empiler les plateaux de manière stable et sécurisée.

REF	Ext. measures Medidas ext. Dimensions ext. W x D x H cm	Usable surface Superficie útil Surface utile cm	Shopping cart icon
P317500B	53 x 32,5 x 6,5	49,2 x 31	1/1
P317500S	53 x 32,5 x 6,5	49,2 x 31	1/1
P317500G	53 x 32,5 x 6,5	49,2 x 31	1/1

Display stands & baskets 14.2

Presentación y expositores / Présentoirs et présentoirs corbeilles



dishwasher

Service and buffet trays
Bandejas de servicio y buffet
Plateaux de service et de buffet

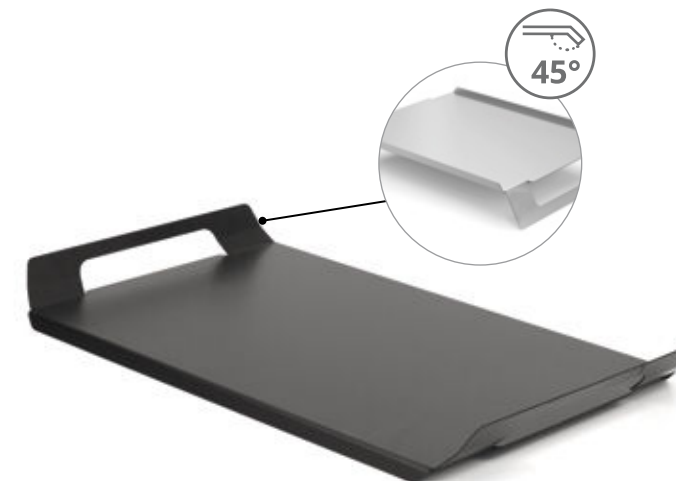

REF	Ext. measures Medidas ext. Dimensions ext. W x D x H cm	Usable surface Superficie útil Surface utile cm	Shopping cart icon
P317100B	53 x 32,5 x 4,6	45,5 x 31	1/1
P317100S	53 x 32,5 x 4,6	45,5 x 31	1/1
P317100G	53 x 32,5 x 4,6	45,5 x 31	1/1

Service and buffet trays
Bandejas de servicio y buffet
Plateaux de service et de buffet

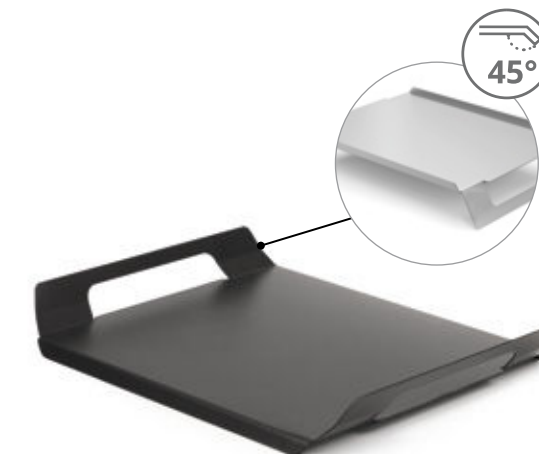

REF	Ext. measures Medidas ext. Dimensions ext. W x D x H cm	Usable surface Superficie útil Surface utile cm	Shopping cart icon
P317200B	43,4 x 32,5 x 4,6	36 x 31	1/1
P317200S	43,4 x 32,5 x 4,6	36 x 31	1/1
P317200G	43,4 x 32,5 x 4,6	36 x 31	1/1

Service and buffet trays
Bandejas de servicio y buffet
Plateaux de service et de buffet

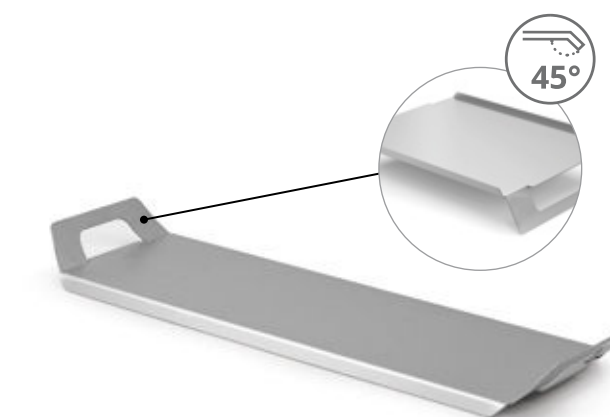

REF	Ext. measures Medidas ext. Dimensions ext. W x D x H cm	Usable surface Superficie útil Surface utile cm	Shopping cart icon
P317300B	51,5 x 18,5 x 4	45,5 x 17	1/1
P317300S	51,5 x 18,5 x 4	45,5 x 17	1/1
P317300G	51,5 x 18,5 x 4	45,5 x 17	1/1

Tray in anodized aluminium
Bandeja servicio en aluminio anodizado
Plateau service en aluminium anodisé

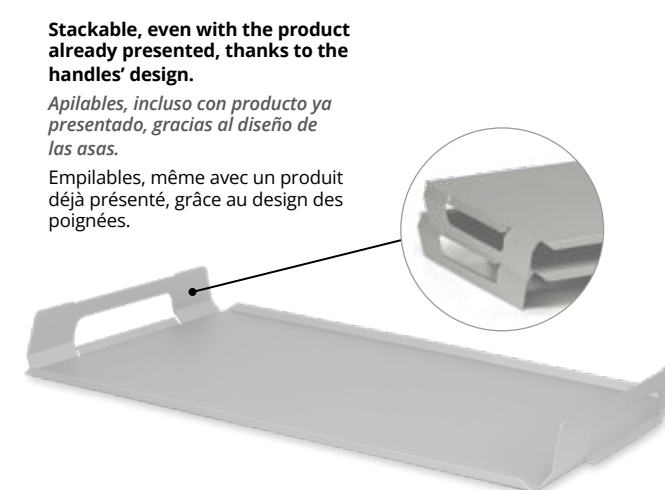

REF	Ext. measures Medidas ext. Dimensions ext. W x D x H cm	Usable surface Superficie útil Surface utile cm	Shopping cart icon
P317600S	60 x 40 x 6,5	57 x 37	1/1

Stackable, even with the product already presented, thanks to the handles' design.
Apilables, incluso con producto ya presentado, gracias al diseño de las asas.

Empilables, même avec un produit déjà présenté, grâce au design des poignées.

14.2 Display stands & baskets

Presentación y expositores / Présentoirs et présentoirs corbeilles



Crown golden buffet mini riser
Expositor dorado mini Crown
Support buffet doré mini Crown

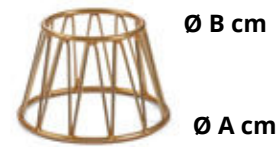

NEW

REF	Ø A cm	Ø B cm	H cm	
P597230	15	10	10	1/6

Crown golden buffet stand
Soporte para buffet dorado Crown
Présentoir buffet doré Crown



NEW

REF	Ø A cm	Ø B cm	H cm	
P597220	25	21	10	1/6

Crown golden buffet stand
Soporte para buffet dorado Crown
Présentoir buffet doré Crown

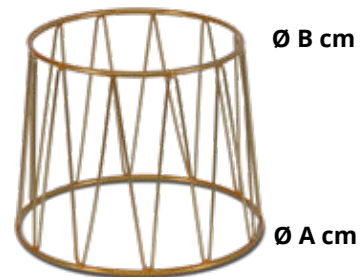

REF	Ø A cm	Ø B cm	H cm	
P597200	25	21	20	1/6

Crown golden buffet stand
Soporte para buffet dorado Crown
Présentoir buffet doré Crown

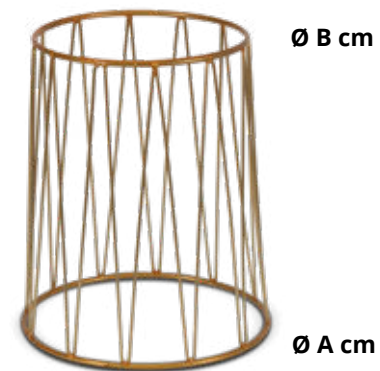

REF	Ø A cm	Ø B cm	H cm	
P597210	25	21	30	1/6

Golden buffet stand
Soporte para buffet dorado
Présentoir buffet doré



REF	Ø cm	H cm	
P597180	21,5	19	1/6

Buffet stand
Soporte para buffe
Présentoir buffet



REF	Ø cm	H cm	
P597190	21,5	19	1/6

Display stands & baskets 14.2

Presentación y expositores / Présentoirs et présentoirs corbeilles



Buffet stand
Soporte para buffet
Présentoir buffet

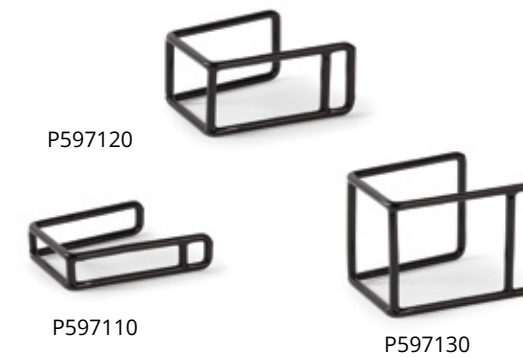

REF	W x D x H cm	
P597110	12,5 x 10,5 x 3	1/24
P597120	12,5 x 10,5 x 6	1/24
P597130	12,5 x 10,5 x 9	1/24

Set of 3 Square Bent Risers
Juego 3 expositores ángulos redondos
Jeu de 3 socles carrés aux angles arrondis

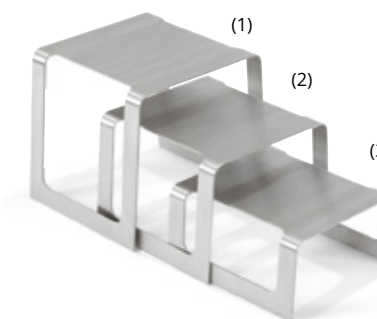

Brushed Stainless Steel
Acero inoxidable pulido
Inox brossé

REF	W x D x H cm	
46009	(1) 20,3 x 20,3 x 20,3	1/1
	(2) 20,3 x 19,1 x 15,2	
	(3) 20,3 x 17,8 x 10,2	

Buffet stand
Soporte para buffet
Présentoir buffet

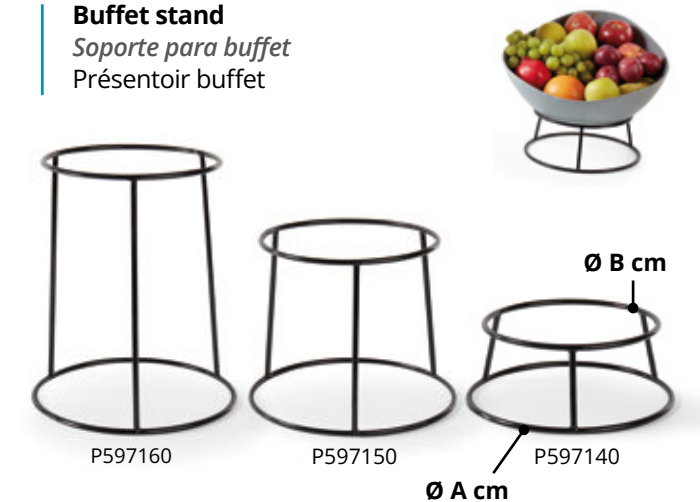

REF	Ø A cm	Ø B cm	H cm	
P597140	25	21	10	1/6
P597150	25	21	20	1/6
P597160	25	21	30	1/6

Set of 3 Square Bent Risers
Juego 3 expositores ángulos redondos
Jeu de 3 socles carrés aux angles arrondis



Brushed Stainless Steel
Acero inoxidable pulido
Inox brossé

Black / Negro / Noir

REF	W x D x H cm	
4600960	(1) 20,3 x 20,3 x 20,3	1/1
	(2) 20,3 x 19,1 x 15,2	
	(3) 20,3 x 17,8 x 10,2	

14.3 Cool line

Cookware body made of 18/10 stainless steel

Cuerpo en acero inoxidable 18/10
Corps en acier inoxydable 18/10



Special lid designed to hold on the side handle

Tapa con diseño especial para apoyo en asa lateral
Couvercle spécial, conçu pour reposer sur la poignée

Ergonomic handles made of cast st/steel

Asas ergonómicas fabricadas en acero inoxidable de fundición
Anses en fonte d'acier inoxydable, ergonomiques

Full Induction Base: 6,5 mm technical sandwich base (stainless steel - aluminium - stainless steel).

Fondo Full Induction: base técnica de 6,5 mm en sándwich (Acero Inoxidable - Aluminio - Acero Inoxidable).
Fond Full Induction : base technique de 6,5 mm en sandwich (acier inoxydable - aluminium - acier inoxydable).

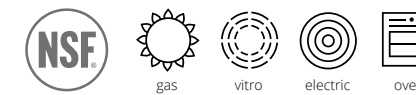

Cool line 14.3

Ref. colour / Ref. color / Ref. couleur couvercle



Sauce pot with lid Cacerola alta con tapa Braising pot with cover

18/10
Stainless steel



REF	Ø cm	H cm	Lts	Shopping icon	Box icon
P490620 + COLOR	20	13,0	3,7	1/1	
P490624 + COLOR	24	14,0	5,8	1/1	
P490628 + COLOR	28	17,5	9,5	1/1	
P490632 + COLOR	32	19,0	14,0	1/1	

Casserole with lid Cacerola baja con tapa Faitout with cover

18/10
Stainless steel



REF	Ø cm	H cm	Lts	Shopping icon	Box icon
P490724 + COLOR	24	9,5	3,9	1/1	
P490728 + COLOR	28	11,0	5,8	1/1	
P490732 + COLOR	32	12,5	8,9	1/1	

Paella pan with lid Paellera con tapa Plat à paella avec couvercle

18/10
Stainless steel



REF	Ø cm	H cm	Lts	Shopping icon	Box icon
P490928 + COLOR	28	6,0	3,7	1/1	
P490932 + COLOR	32	6,0	4,7	1/1	

Saucepan Cazo recto Casserole

18/10
Stainless steel



REF	Ø cm	H cm	Lts	Shopping icon	Box icon
P490016 + COLOR	16	7,5	1,5	1/1	

Lid holder Soporte para tapas Support de couvercle

SS
Stainless steel

PVC



NEW

Non-slip coating
Revestimiento antideslizante
Revêtement antidérapant

REF	W x D x H cm	Shopping icon	Box icon
P597240	11,5 x 11,5 x 4	1/12	



14.3 Cool line



Non-stick sandwich bottom GN container
 Cubeta GN antiadherente con fondo difusor
 Bac GN anti-adhésive avec fond thermo-diffuseur

PATENTED EXCLUSIVE

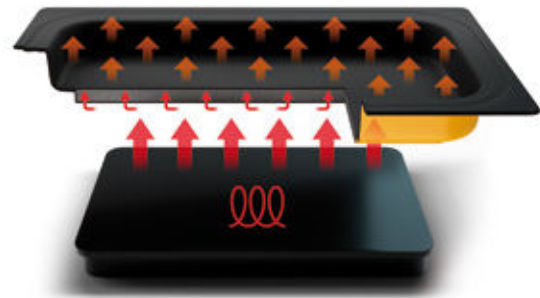

IDEA! Ideal for buffet presentations.
 Ideal para presentación buffet.
 Idéal pour présentation buffet.

REF	Type Tipo	H mm	Lts	🛒/📦
P1106F3A	1/1	65	8,30	1/1
P1106F3N	1/1	65	8,30	1/1
P1106F3R	1/1	65	8,30	1/1
P1106F3G	1/1	65	8,30	1/1
P1106F3	1/1	65	8,30	1/1
P1206F3A	1/2	65	4,10	1/1
P1206F3N	1/2	65	4,10	1/1
P1206F3R	1/2	65	4,10	1/1
P1206F3G	1/2	65	4,10	1/1
P1206F3	1/2	65	4,10	1/1

Ref. colour / Ref. color / Ref. couleur couvercle



P1106F3A



P1106F3R



P1106F3

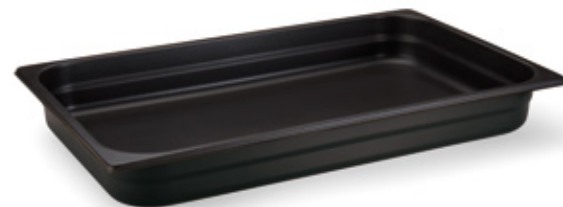

P1106F3N



P1106F3G

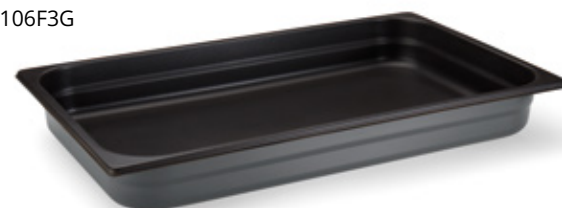

IDEA! Ideal for heated buffets
 Ideal para buffet caliente
 Idéal pour buffets chauffées

Enamelled steel GN container
 Cubeta GN de acero esmaltado
 Bac GN en acier émaillé



Suitable for all types of temperature-maintaining plates.

Apto para todo tipo de placa mantenedora de temperatura.
 Convient à tous types de plaques de maintien en température.

P131165



P131120



REF	Type Tipo	H cm	🛒/📦
P131120	1/1	2,0	1/1
P131165	1/1	6,5	1/1
P131220	1/2	2,0	1/1
P131265	1/2	6,5	1/1

See products on
 Ver productos en / Voir produits en page

P. 363

Warming induction units
 Placas mantenedoras inducción
 Plaques chauffantes à induction



14.3 Bronze cookware

Batería cocina bronce / Batterie de cuisine bronze

Transparent glass lid with stainless steel rim and black handle.

Tapa de cristal transparente con borde de acero inoxidable y mango en color negro.

Couvercle en verre transparent avec rebord en acier inoxydable et manche noir.

Escape valve for steam

Válvula de salida de vapor
Clapet de sortie de la vapeur

Exterior painted in an elegant bronze colour.

Exterior pintado en elegante color bronce.

Extérieur avec revêtement bronze élégant.

Made of cast aluminium with high resistance to deformation and excellent thermal performance.

Fabricada en aluminio de fundición de gran resistencia a la deformación y con excelentes prestaciones térmicas.

Fabriqué en fonte d'aluminium très résistante à la déformation et doté d'excellentes performances techniques.

Ground base

Fondo torneado
Fond dressé

Elegant, robust, versatile

Elegante, robusta, versátil / Élégante, solide, polyvalente



Rotisserie
Rustidera
Plat à rôtir



REF	W x D x H cm	L		
P152035B	35 x 25 x 7,5	5	1/6	
P152935	Transparent lid Tapa transparente Couvercle transparent		1/1	

Deep casserole without lid
Cazuela alta sin tapa
Braising sans couvercle



REF	Ø cm	H cm	L		
P151020B	20	9	2,50	1/12	
P151024B	24	10	4,00	1/6	
P151028B	28	12	6,65	1/6	

Bronze cookware 14.3

Batería cocina bronce / Batterie de cuisine bronze

Shallow casserole without lid
Cazuela baja sin tapa
Cocotte sans couvercle



REF	Ø cm	H cm	L		
P141024B	24	5,8	2,25	1/10	
P141028B	28	7,5	4,00	1/6	
P141032B	32	8,0	5,75	1/6	

Glass lid with stainless steel rim
Tapa de cristal con borde de acero inoxidable
Couvercle en verre avec rebord en acier inoxydable



REF	Ø cm		
P154020	20	1/1	
P154024	24	1/1	
P154028	28	1/1	
P154032	32	1/1	

See products on / Ver productos en / Voir produits en page

P. 86

BLACK SERIES



14.3 Miramar® cookware

Batería de cocina para presentación / Batterie de cuisine-Présentation



Cookware goes straight from the kitchen to your buffet in the same vessel.

Variety of cookware items for any menu.

La batería pasa directamente de la cocina a su buffet en el mismo recipiente.

Variación de utensilios de cocina para todo tipo de comidas.

Passez directement de la cuisine au buffet sans changer de plat.

Variété d'articles pour tout type de menu.



Miramar® cookware 14.3

Batería de cocina para presentación / Batterie de cuisine-Présentation



Satin-finished interior and exterior

Asas y mangos brillantes
Des poignées ultra-brillantes

Handle design serves as a convenient cover rest

Mangos diseñados para la sujeción de las tapas
La conception des manches et poignées sert de reposecouvercle

Mirror-finished handles

Interior y exterior satinados
Finition satinée à l'intérieur et l'extérieur

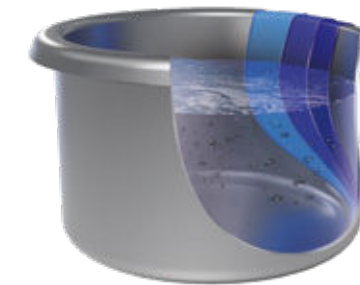

Extremely durable-thick 3-ply construction provides induction compatibility and will last a lifetime

Extremadamente duradero: la construcción gruesa de 3 capas proporciona compatibilidad con inducción y durará toda la vida

Extrêmement durable : la construction épaisse à 3 couches offre une compatibilité avec l'induction et durera toute une vie



14.3 Miramar® cookware

Batería de cocina para presentación / Batterie de cuisine-Présentation



Casseroles

Cacerola baja con tapa
Faitouts avec couvercle dôme bas



REF	Ø cm	H cm	L	🛒/📦
49410	20,0	9,5	2,9	1/1
49411	24,1	11,3	4,8	1/1
49441	25,8	18,9	6,6	1/1

Bazier pan

Cacerola baja
Plat à braiser



REF	Ø cm	H cm	L	🛒/📦
49425	30	8,9	6	1/1

Sauté Pan

Sartén
Sauteuse



REF	Ø cm	H cm	L	🛒/📦
49416	20,3	5,1	1,2	1/1
49413	26,0	4,8	2,1	1/1

French Omelet Pans

Paellera
Poêle à omelette



REF	cm	H cm	L	🛒/📦
49417	20,3 x 20,3	6	1,7	1/1
49424	26 x 26	6	2,9	1/1

Stir Fry Pan

Sautex bombeado
Wok/plat de service



REF	Ø cm	H cm	L	🛒/📦
49418	30,2	9,4	4,9	1/1
49428	32,1	9,2	6,0	1/1

Sauce Pans

Cazo
Casserole



REF	Ø cm	H cm	L	🛒/📦
49414	15,9	9,5	1,9	1/1
49430	14,0	6,8	0,9	1/1

Miramar® cookware 14.3

Batería de cocina para presentación / Batterie de cuisine-Présentation



Food Pans

Fuente
Plat



REF	For / Para / Pour	W x D x H cm	L	🛒/📦
49434	-	29,5 x 23,6 x 5,1	2,6	1/1
49432	-	37,3 x 30 x 5,1	4,4	1/1
49435W	-	29,5 x 23,6 x 5,1	2,6	1/1
49433W	-	37,3 x 30 x 5,1	4,4	1/1
49434C	49434 - 49435W	29,5 x 23,5 x 6,4	-	1/6
49432C	49432 - 49433W	37,3 x 30 x 6,4	-	1/4

French Oven with cover

Fuente Horno con tapa
Cocotte avec couvercle



REF	W x D x H cm	L	🛒/📦
49431	363 x 282 x 9,7	6,6	1/1

Oval presentation dish

Fuente presentación ovalada
Fontaine de présentation ovale



REF	W x D x H cm	L	🛒/📦
8230210	33,3 x 22,5 x 6,4	1,9	1/1
8231420	48,4 x 30,2 x 5,1	2,8	1/1

Oval Au Gratin

Fuente para gratinar
Plat à gratin ovale



* Mirror-finished interior
Acabado brillante
Ultra-brillant

REF	For / Para / Pour	W x D x H cm	L	🛒/📦
49420	-	25,4 x 19,1 x 5,2	1,7	1/1
49420C	49420	25,4 x 19,1 x 6,4	-	1/6
49412*	-	30,5 x 21,6 x 5,1	2,5	1/1
49412C*	49412	30,5 x 21,6 x 6,4	-	1/6
49442	-	40,6 x 22,9 x 5,1	3,5	1/1
49442C	49442	40,6 x 22,9 x 6,4	-	1/1
49445	-	52,3 x 22,9 x 10,2	6,6	1/1

Covers

Tapa
Couvercles



REF	For / Para / Pour	Ø cm	H mm	🛒/📦
49429	49428	35,6	120	1/1
49426	49418 - 49425	32,4	102	1/1
49419	49416 - 49417	20,3	51	1/1
49423	49413 - 49424	27,3	51	1/1
49427	49430	14,9	51	1/1

Rectangular presentation dish

Fuente presentación rectangular
Fontaine de présentation rectangulaire



REF	W x D x H cm	L	🛒/📦
8231810	33,2 x 27 x 2,5	1,5	1/1
8230720	33,2 x 27 x 7	3,2	1/1

14.3 Miramar® cookware

Batería de cocina para presentación / Batterie de cuisine-Présentation

TEMPLATES PLANTILLAS GABARITS

Stainless Steel Plain / Acero inox. / Inox
Resin / Resina / Résine
Night Sky / Negro / Bleu nuit

+150 °C



One large and one small round

Plantilla agujeros redondo grande y pequeño
Une grande découpe ronde et une petite découpe ronde

1/1



REF	cm		
8242014	53,6 x 32,4		1/1

One large oval

Plantilla agujero oval grande
Une grande découpe ovale

1/1



REF	cm		
8242314	53,6 x 32,4		1/1
8242310	53,6 x 32,4		1/1

One large round and one small round

Plantilla agujeros redondo grande y pequeño
Une grande découpe ronde et une petite découpe ronde

1/1

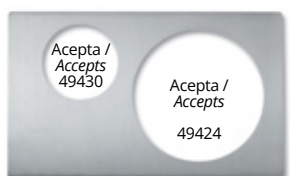

REF	cm		
8242414	53,6 x 32,4		1/1

Two large round

Plantilla agujeros redondos grandes
2 grandes découpes rondes

1/1



REF	cm		
8242514	53,6 x 32,4		1/1

One large round

Plantilla agujero redondo grande
Une grande découpe ronde

1/1



REF	cm		
8242614	53,6 x 32,4		1/1
8242610	53,6 x 32,4		1/1

1/1



REF	cm		
8242714	53,6 x 32,4		1/1
8242710	53,6 x 32,4		1/1

Solid baseplate

Plantilla sólida
Modèle solide

1/1



REF	cm		
8242814	53,6 x 32,4		1/1

One small food pan

Plantilla para fuente
Un petit bac à aliments

1/1

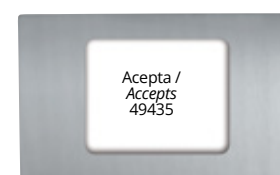

REF	cm		
8242814	53,6 x 32,4		1/1

One large food pan

Plantilla para fuente
Un grand bac à aliments

1/1

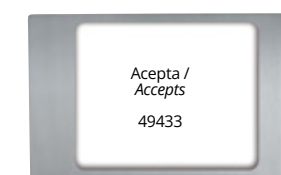

REF	cm		
8242914	53,6 x 32,4		1/1

Two small food pans

Plantilla para fuente
Deux petits bacs à aliments

1/1



REF	cm		
8243014	53,6 x 32,4		1/1

One large and one medium oval

Plantilla agujeros ovales grande y pequeño
Une grande découpe ronde et une moyenne découpe ovale

1/1

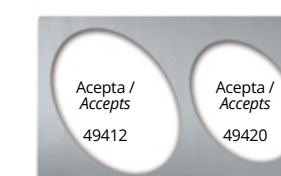

REF	cm		
8243114	53,6 x 32,4		1/1

Two medium oval

Plantilla agujeros redondos medianos
Deux découpes ovales moyennes

1/1



REF	cm		
8243214	53,6 x 32,4		1/1
8243210	53,6 x 32,4		1/1

One large and one medium round

Plantilla agujeros redondos grande y mediano
Une grande découpe ronde et une moyenne découpe ronde

1/1



REF	cm		
8243314	53,6 x 32,4		1/1

+150 °C

14.4 Super shapes

Buffet presentation steam table pans
Cubetas presentación buffet / Bacs présentation buffet

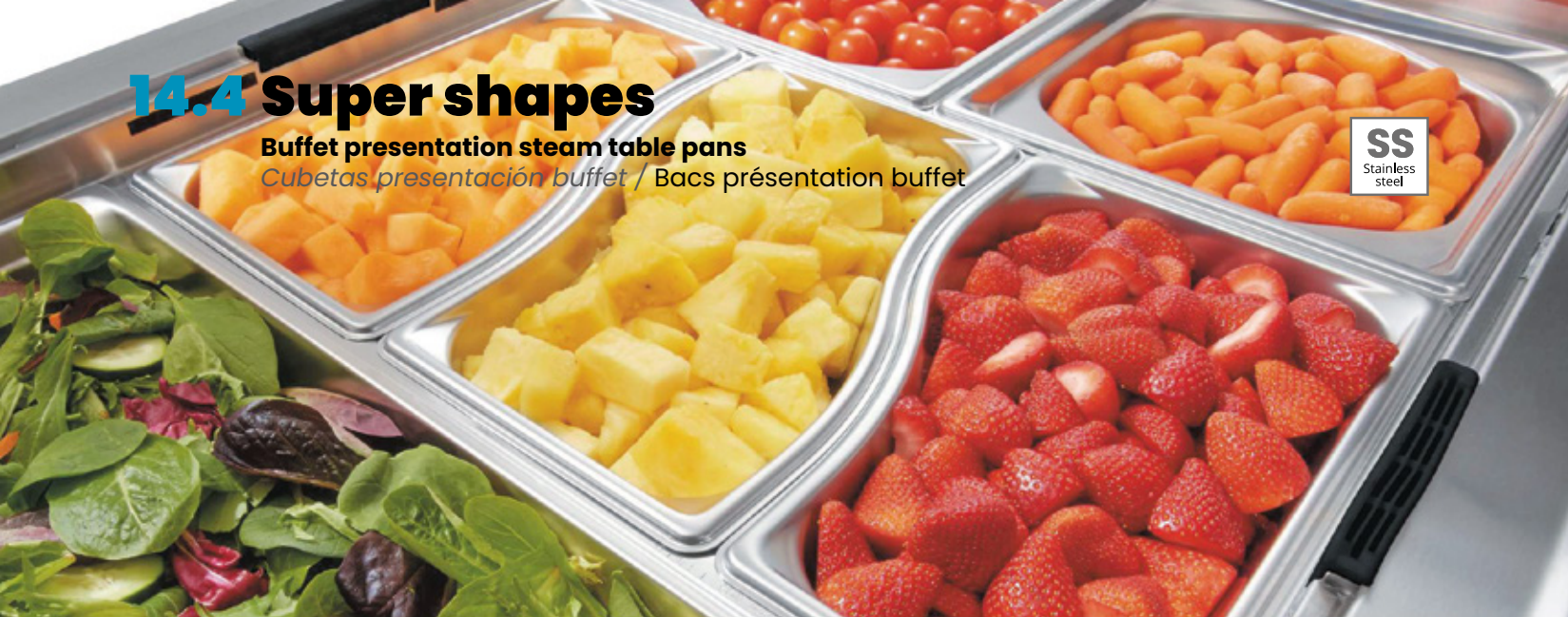

SS
Stainless
steel

Full Oval
Ovalada
Ovale

NSF

1/1



REF	W x D x H cm	L	Shopping icon
3101015	53 x 32,5 x 5,1	3,7	1/6
3101020	53 x 32,5 x 6,5	4,6	1/6
3101040	53 x 32,5 x 10	7,8	1/6

Half Oval
Óvalo
Ovale

NSF

1/2



REF	cm	L	Shopping icon
3102015	26,5 x 32,5 x 5,1	1,6	1/6
3102020	26,5 x 32,5 x 6,5	2,1	1/6
3102040	26,5 x 32,5 x 10	3,5	1/6

Full Hexagon
Hexágono
Hexagonal

NSF

1/1



REF	W x D x H cm	L	Shopping icon
3101220	53 x 32,5 x 6,5	5,0	1/6
3101240	53 x 32,5 x 10	8,8	1/6

Full Hexagon
Hexágono
Hexagonal

NSF

1/2



REF	W x D x H cm	L	Shopping icon
3102220	26,5 x 32,5 x 6,5	2,1	1/6

Full Kidney
Reniforme
Rein

NSF

1/1



REF	W x D x H cm	L	Shopping icon
3101120	53 x 32,5 x 6,5	4,8	1/6

Super shapes 14.4

Buffet presentation steam table pans
Cubetas presentación buffet / Bacs présentation buffet

SS
Stainless
steel

Half Kidney
Reniforme
Rein

NSF

1/2



REF	W x D x H cm	L	Shopping icon
3102120	26,5 x 32,5 x 6,5	2,1	1/6

Short Wild Pan
Wild Pan corta
Wild Pan court

NSF

1/2



REF	W x D x H cm	L	Shopping icon
3100220	26,5 x 32,5 x 6,5	3,9	1/6
3100240	26,5 x 32,5 x 10	6,1	1/6

Inner Wild Pan
Wild Pan interna
Troisième Wild Pan intérieur

NSF

1/3



REF	W x D x H cm	L	Shopping icon
3100321	17,6 x 32,5 x 6,5	2,5	1/6
3100341	17,6 x 32,5 x 10	3,6	1/6

Long Wild Pan
Wild Pan larga
Wild Pan long

NSF

2/4

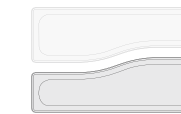

REF	W x D x H cm	L	Shopping icon
3100020	53 x 16,5 x 6,5	3,5	1/6
3100040	53 x 16,5 x 8,9	4,8	1/6

Third Outer Wild Pan
Wild Pan externa
Troisième Wild Pan extérieur

NSF

1/3



REF	W x D x H cm	L	Shopping icon
3100320	17,6 x 32,5 x 6,5	2,5	1/6
3100340	17,6 x 32,5 x 10	3,6	1/6

Adaptor Bar
Barra adaptadora
Barre intermédiaire

NSF

REF	For / Para / Pour	Shopping icon
75015	3100020 / 3100040	1/12
75013	3100220 / 3100240 / 3100320 / 3100341 / 3100340	1/12

14.5 CUBIC®

EXCLUSIVE
PATENT PENDING

Modularity that reflects maximum expression
Modularidad a la máxima expresión
Modularité à son expression maximale



Discover the best buffet display, thanks to its:

- It allows to optimize exhibition space
- It reduces assembly and disassembly time
- Ease of transport and storage
- Elegant and original
- It offers multiple and varied combinations

Descubre la mejor presentación de buffet, porque:

- Permite optimizar espacio de exposición
- Reduce el tiempo de montaje y desmontaje
- Facilidad de transporte y almacenaje
- Elegante y original
- Ofrece múltiples y variadas combinaciones

Découvrez la meilleure présentation buffet, grâce à son :

- Permet d'optimiser l'espace d'exposition
- Réduit le temps de montage et de démontage
- Facilité de transport et de stockage
- Élégant et original
- Offre des combinaisons multiples et variées



CUBES / CUBO / CUBES
Top cover convertible on mini shelf, stackable, multicombinations, saving space when storing parts, special waterproof treatment.

Con tapa superior transformable en mini estante, apilables entre sí, múltiples combinaciones posibles, ahorro de espacio durante el almacenaje de las piezas, tratamiento hidrófugo especial.

Couvercle transformable en mini rayon, empilables, multiples combinaisons possibles, gain d'espace pour le stockage des composants, traitement hydrofuge spécial.

SHELVES / ESTANTES / TABLETTES
Three lengths: 50, 80 and 100 cm, two depths: 18 and 35 cm, undeformable wood. Special waterproof treatment.

Tres longitudes: 50, 80 y 100 cm, dos profundidades: 18 y 35 cm, madera indeformable. Tratamiento hidrófugo especial.

Trois longueurs: 50, 80 et 100 cm, deux profondeurs: 18 et 35 cm. Bois indéformable. Traitement hydrofuge spécial.

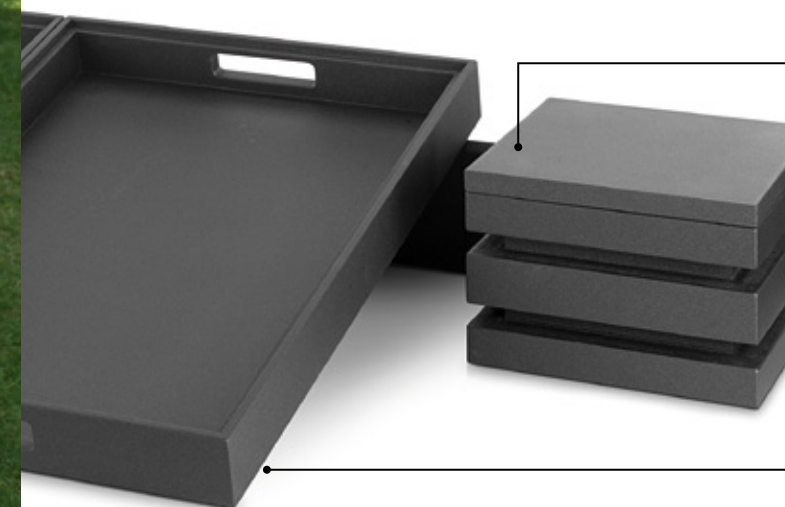
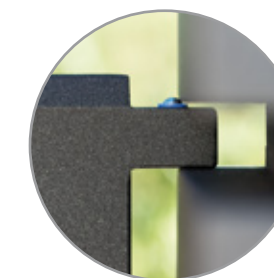

Stackable trays
Bandejas apilables entre sí
Plateaux empilables entre eux

14.5 Cubic

Display buffet cases Muebles presentación buffet Meubles présentation buffet

Suitable for gastronorm sizes
Adaptado a medidas gastronorm
Adaptés aux mesures gastronorme

Made of wood with special waterproof treatment, easy to clean

Fabricados en madera con tratamiento hidrófugo especial, de fácil limpieza

Fabriqué en bois avec un traitement hydrofuge spécial, facile à nettoyer



Cubic 14.5

Presentation kit for 4 square bowls
Conjunto soporte 4 bols cuadrados
Kit support 4 bols carrés

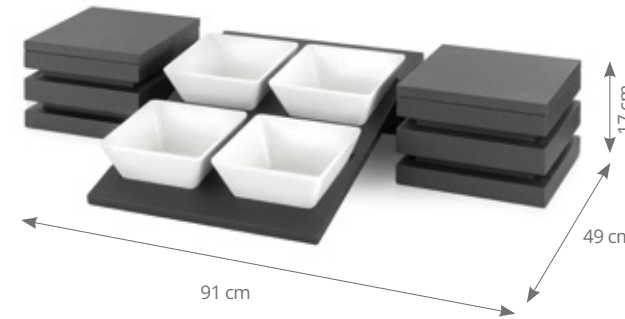

Includes : 2 cubes with lid 1 crossbar 50 cm length 1 displayer for 4 bowls 4 melamine bowls.	<i>Incluye:</i> 2 cubos con tapa 1 travesaño de 50 cm 1 presentador de 4 bols 4 bols de melamina.	Inclus : 2 cubes avec couvercle 1 longeron 50 cm 1 présentoir pour 4 bols 4 bols mélamine.
---	---	---

REF 
P905504 1/1

Presentation kit for 6 square bowls
Conjunto soporte 6 bols cuadrados
Kit support 6 bols carrés

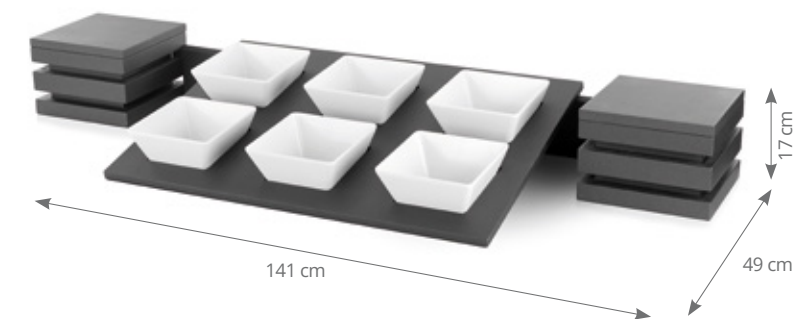

Includes : 2 cubes with lid 1 crossbar 100 cm length 1 displayer for 6 bowls 6 melamine bowls.	<i>Incluye:</i> 2 cubos con tapa 1 travesaño de 100 cm 1 presentador de 6 bols 6 bols de melamina.	Inclus : 2 cubes avec couvercle 1 longeron 100 cm 1 présentoir pour 6 bols 6 bols mélamine.
--	--	--

REF 
P905506 1/1

Wooden buffet serving trolley Carro madera presentación buffet Chariot buffet en bois présentation buffet

Outstanding combination of wood and aluminium
Elegante combinación de madera y aluminio
Combinaison élégante en bois et en aluminium

Suitable for gastronorm sizes
Adaptado a medidas gastronorm
Adaptés aux mesures gastronorme

Possible transformation from an expositor trolley to a presentation table

Posibilidad de convertir el carro expositor en mesa de presentación

Possibilité de transformer le chariot d'exposition en une table de présentation

Wood with special waterproof treatment, easy to clean
Tratamiento hidrófugo especial, de fácil limpieza
Bois avec un traitement hydrofuge spécial, facile à nettoyer



Two levels presentation kit for 6 square bowls
Conjunto 2 niveles soporte 6 bols
Kit support 6 bols carrés deux niveaux

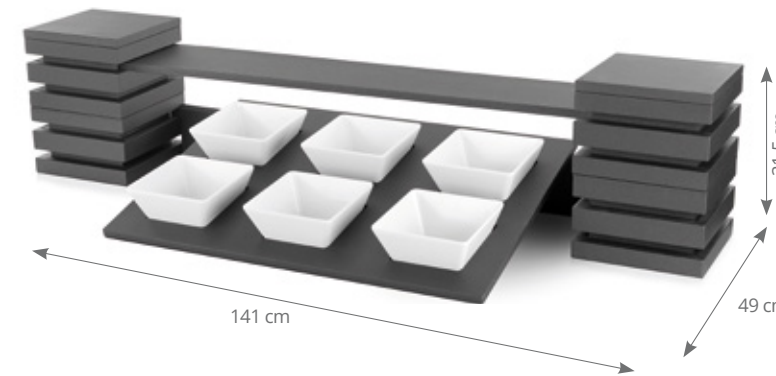

Includes : 4 cubes with lid 1 crossbar 100 cm length 1 displayer for 6 bowls 6 melamine bowls 1 narrow shelf 100 cm	<i>Incluye:</i> 4 cubos con tapa 1 travesaño de 100 cm 1 presentador de 6 bols 6 bols de melamina 1 estante estrecho de 100 cm	Inclus : 4 cubes avec couvercle 1 longeron 100 cm 1 présentoir pour 6 bols 6 bols mélamine 1 tablette étroite 100 cm
--	---	--

REF 
P905516 1/1

Presentation kit for 8 square bowls
Conjunto soporte 8 bols cuadrados
Kit support 8 bols carrés

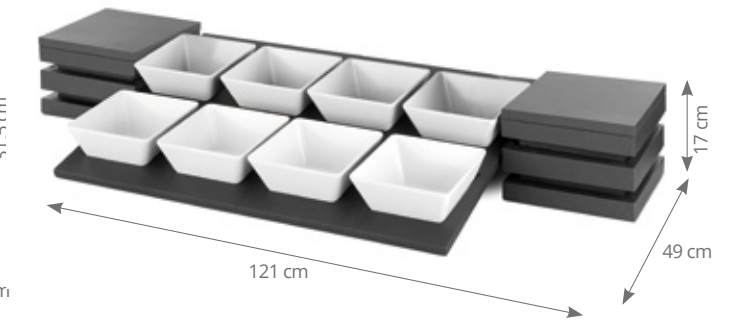

Includes : 2 cubes with lid 1 crossbar 80 cm length 2 displayers for 4 bowls 8 melamine bowls	<i>Incluye:</i> 2 cubos con tapa 1 travesaño de 80 cm 2 presentadores de 4 bols 8 bols de melamina	Inclus : 2 cubes avec couvercle 1 longeron 80 cm 2 présentoirs pour 4 bols 8 bols mélamine
---	--	---

REF 
P905508 1/1

Two levels presentation kit for 8 square bowls
Conjunto 2 niveles soporte 8 bols
 Kit support 8 bols carrés deux niveaux

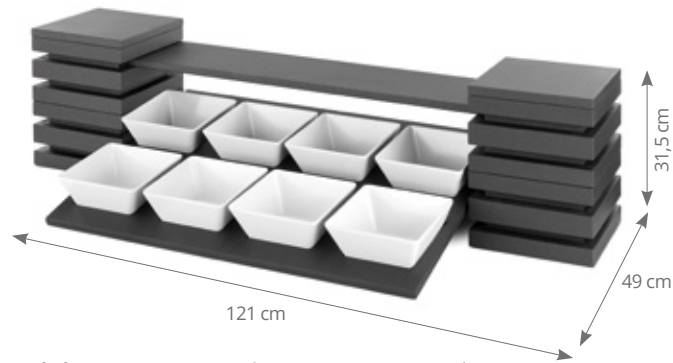

Includes :	<i>Incluye:</i>	Inclus :
4 cubes with lid	4 cubos con tapa	4 cubes avec couvercle
1 crossbar 80 cm length	1 travesaño 80 cm	1 longeron 80 cm
2 displayers for 4 bowls	2 presentadores de 4 bols	2 présentoirs pour 4 bols
8 melamine bowls	8 bols de melamina	8 bols mélamine
1 narrow shelf 80 cm	1 estante estrecho 80 cm	1 tablette étroite 80 cm

REF
P905518 1/1

Basic two levels presentation kit
Conjunto básico estante 2 niveles
 Kit basique présentation 2 niveaux



Includes :	<i>Incluye:</i>	Inclus :
4 cubes with lid	4 cubos con tapa	4 cubes avec couvercle
1 wide shelf 100 cm	1 estante ancho 100 cm	1 tablette large 100 cm
1 narrow shelf 100 cm	1 estante estrecho 100 cm	1 tablette étroite 100 cm

REF
P905400 1/1

Two levels presentation kit for 40x40 cm trays
Conjunto 2 niveles bandejas 40x40 cm
 Kit présentation 2 niveaux pour plateaux 40x40 cm

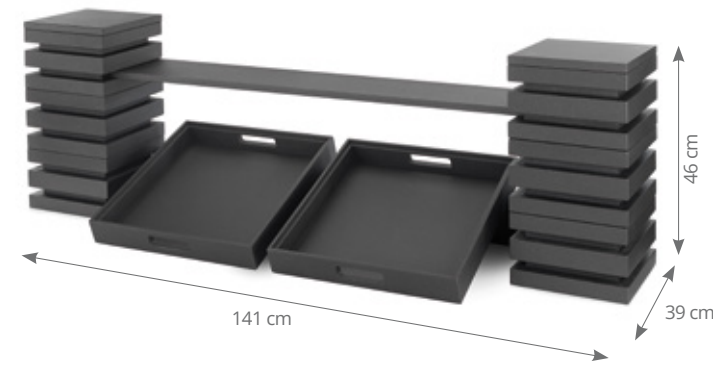

Includes :	<i>Incluye:</i>	Inclus :
6 cubes with lid	6 cubos con tapa	6 cubes avec couvercle
1 crossbar 100 cm length	1 travesaño de 100 cm	1 longeron 100 cm
2 serving trays 40 x 40 cm	2 bandejas presentación de 40 x 40 cm	2 plateaux présentation 40 x 40 cm
1 narrow shelf 100 cm	1 estante estrecho de 100 cm	1 tablette étroite 100 cm

REF
P905310 1/1

Two trays 60x40 cm presentation kit
Conjunto 2 bandejas 60x40 cm
 Kit présentation pour deux plateaux 60x40 cm

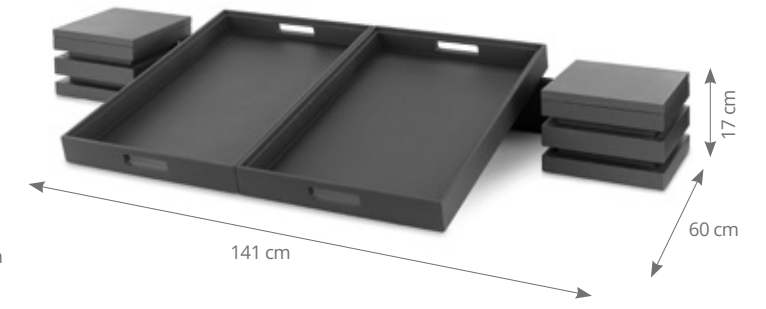

Includes :	<i>Incluye:</i>	Inclus :
2 cubes with lid	2 cubos con tapa	2 cubes avec couvercle
1 crossbar 100 cm length	1 travesaño de 100 cm	1 longeron 100 cm
2 serving trays 60 x 40 cm	2 bandejas presentación de 60 x 40 cm	2 plateaux présentation 60 x 40 cm

REF
P905320 1/1

"L" shape two levels presentation kit
Conjunto estante dos niveles forma "L"
 Kit présentation "L" 2 niveaux

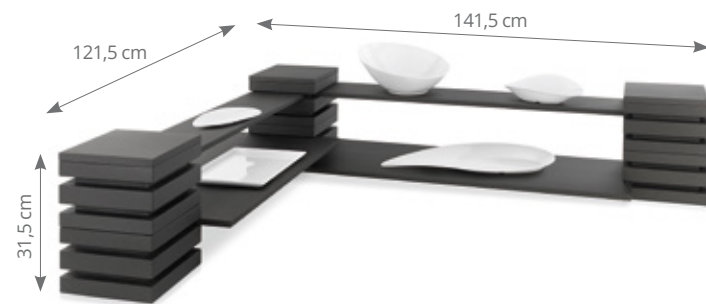

Includes :	<i>Incluye:</i>	Inclus :
6 cubes with lid	6 cubos con tapa	6 cubes avec couvercle
1 wide shelf 100 cm	1 estante ancho 100 cm	1 tablette large 100 cm
1 narrow shelf 100 cm	1 estante estrecho 100 cm	1 tablette étroite 100 cm
1 wide shelf 80 cm	1 estante ancho 80 cm	1 tablette large 80 cm
1 narrow shelf 80 cm	1 estante estrecho 80 cm	1 tablette étroite 80 cm

REF
P905410 1/1

Two trays 40x40 cm presentation kit
Conjunto 2 bandejas presentación 40x40 cm
 Kit présentation pour deux plateaux 40x40 cm



Includes :	<i>Incluye:</i>	Inclus :
4 cubes with lid	4 cubos con tapa	4 cubes avec couvercle
1 crossbar 100 cm length	1 travesaño de 100 cm	1 longeron 100 cm
2 serving trays 40 x 40 cm	2 bandejas presentación de 40 x 40 cm	2 plateaux présentation 40 x 40 cm

REF
P905300 1/1

Two levels for trays 60x40 cm presentation kit
Conjunto 2 niveles para bandejas 60x40 cm
 Kit présentation 2 niveaux pour plateaux 60x40 cm

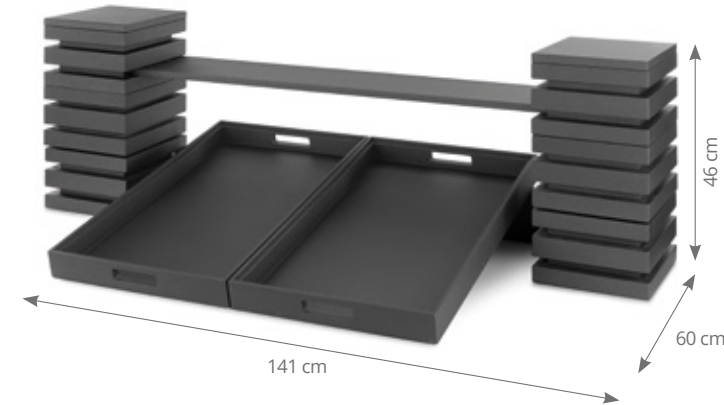

Includes :	<i>Incluye:</i>	Inclus :
6 cubes with lid	6 cubos con tapa	6 cubes avec couvercle
1 crossbar 100 cm length	1 travesaño de 100 cm	1 longeron 100 cm
2 serving trays 60 x 40 cm	2 bandejas presentación de 60 x 40 cm	2 plateaux présentation 60 x 40 cm
1 narrow shelf 100 cm	1 estante estrecho de 100 cm	1 tablette étroite 100 cm

REF
P905340 1/1

Three levels 2/3 GN stand
Expositor GN 2/3, tres niveles
 Présentoir 3 niveaux pour GN 2/3



Includes / Incluye / Inclus :
 3 GN containers 2/3 20 mm
 3 cubetas GN 2/3 20 mm
 3 bags GN 2/3 20 mm



REF **W x D x H cm**
P904790 65 x 38 x 59 1/1

GN skewer serving tray
Bandeja GN presentación pinchos
Plateau GN présentation piques



GN 1/1

Includes:
wooden tray
oak melamine tray
interior skewer stand

Incluye:
bandeja madera
bandeja melamina roble
soporte interior pinchos

Inclus:
plateau bois
plateau mélamine chêne
support intérieur piques

REF	W x D x H cm	Holes Agujeros Ø cm	Piques Pinchos		
P904350	53,9 x 33,5 x 7,7	0,4	84	1/1	

Buffet wine cooler
Enfriador botellas buffet
Rafraîchisseur bouteilles



GN 1/1

Includes:
wooden tray
1/1 GN pan 150 mm

Incluye:
bandeja madera
cubeta GN 1/1 150 mm

Inclus:
plateau bois
bac GN 1/1 150 mm

REF	W x D x H cm		
P904155	57 x 37 x 14,5	1/1	

Napkin and tea & sugar bags dispenser
Servilletero y dispensador bolsas te y azúcar
Distributeur serviettes et des saquettes thé & sucre



P904720



P904725

REF	W x D x H cm		
P904720	22 x 22 x 5,5	1/1	
P904725	22 x 22 x 5,5	1/1	

Tea & sugar bag holder
Soporte bolsas te y azúcar
Support pour saquettes de thé & sucre



For / Para / Pour ref. P904.720

REF	W x D x H cm		
P904721	19,8 x 19,8 x 4,9	1/1	

1/1 GN wooden table + cutting board
Mesita buffet GN 1/1 + taco madera
Table GN 1/1 en bois + planche à découper



REF	W x D x H cm		
P904850	53 x 32,5 x 12	1/1	

Low wooden table + cutting board
Mesita buffet baja + taco madera
Table basse en bois + planche à découper



P904810

P904820

REF	W x D x H cm		
P904810	32,5 x 22 x 12	1/1	
P904820	32,5 x 22 x 16,5	1/1	

Cutting board for wooden table
Taco madera para mesita buffet
Planche à découper pour table en bois



P904804



P904809

REF	W x D x H cm		
P904804 ¹	29,2 x 18,7 x 22	1/1	
P904809 ²	49,7 x 29,2 x 22	1/1	

(1) For / Para / Pour P904810 / P904820
(2) For / Para / Pour P904850

Methacrylate holder
Portamenús metacrilato
Porte-menus méthacrylate



REF	cm		
P20072	6 x 6	1/1	



See products on / Ver productos en / Voir produits en page

P. 549

Stainless steel plate covers
Tapas Acero inoxidable para platos
Inox couvercles à assiette





ROOM SERVICE

Cutlery-holder tray
Bandeja porta-cubiertos
Plateau porte-couverts



GN 1/1



Stackables.
Apilables.
Empilables.

4 compartments
4 compartimentos
4 compartiments
303 x 115 mm

REF	W x D x H cm	Shopping icon
P904780	53,9 x 33,5 x 7,7	1/1

Serving tray
Bandeja servicio y presentación
Plateau service et présentation



Stackables.
Apilables.
Empilables.

IDEA! Room service tray.
Perfecta para servicio de habitaciones.
Plateau idéal pour service de chambre.

REF	W x D x H cm	Shopping icon
P904760	60 x 40 x 6,5	1/1

Serving tray
Bandeja presentación
Plateau présentation



Stackables.
Apilables.
Empilables.

REF	W x D x H cm	Shopping icon
P904740	40 x 40 x 6,5	1/1

1/1 GN serving tray
Bandeja servicio y presentación GN 1/1
Plateau service et présentation GN 1/1



GN 1/1



Stackables.
Apilables.
Empilables.

1/1 Gastronorm container not included.
No incluye cubeta gastronorm 1/1.
Bac gastronorme 1/1 non inclus.

REF	W x D x H cm	Shopping icon
P904711	53,9 x 33,5 x 7,7	1/1



Wooden cube with lid
Cubo con tapa madera
Cube en bois avec couvercle

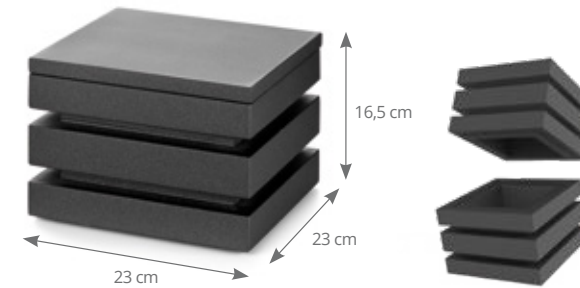

REF	Shopping icon
P904600	1/1

Wooden narrow shelf
Estante madera estrecho
Tablette en bois étroite

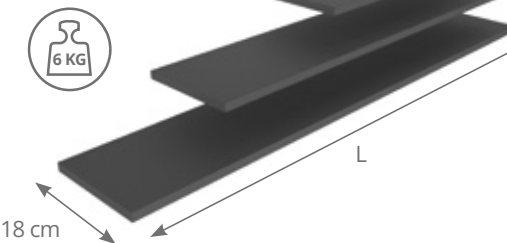

REF	L cm	Shopping icon
P904650	50	1/1
P904680	80	1/1
P904610	100	1/1

Displayer for 4 melamine bowls
Presentador 4 bols melamina cuadrados
Présentoir 4 bols mélamine

For square bowls
Para bols cuadrados
Pour bols carrés
180 x 180
REF. P22.202

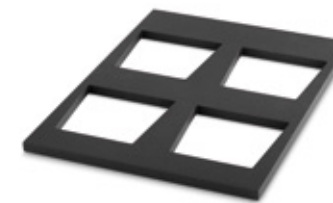

REF	W x D x H cm	Shopping icon
P904937	37,5 x 50 x 1,5	1/1

Crossbar buffet trays
Travesaño soporte bandejas
Longerons pour plateaux buffet



Wooden lid
Tapa madera
Couvercle en bois



REF	Shopping icon
P904660	1/1

Wooden wide shelf
Estante madera ancho
Tablette en bois large

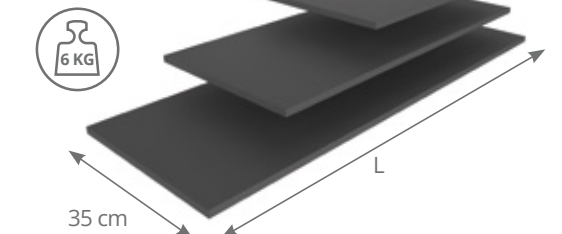

REF	L cm	Shopping icon
P904652	50	1/1
P904682	80	1/1
P904612	100	1/1

Displayer for 6 melamine bowls
Presentador 6 bols melamina cuadrados
Présentoir 6 bols mélamine

For square bowls
Para bols cuadrados
Pour bols carrés
180 x 180
REF. P22.202



REF	W x D x H cm	Shopping icon
P904975	75 x 50 x 1,5	1/1

REF	W x D x H cm	Shopping icon
P904950	50 x 12,4 x 2	1/1
P904980	80 x 12,4 x 2	1/1
P904990	100 x 12,4 x 2	1/1

Perforated buffet display
Buffet perforado
Buffet perforé



Includes:
Wooden frame perforated 1/1 GN pan 65 mm gastronorm pan 1/1 20 mm roll-top lid.

Incluye:
Marco madera bandeja perforada GN 1/1 65 mm cubeta GN 1/1 20 mm cúpula roll-top

Inclus:
Cadre en bois bac GN 1/1 65 mm perforé bac GN 1/1 20 mm couvercle roll-top

REF	W x D x H cm	
P904165	57 x 37 x 31	1/1

Standard buffet display
Buffet estandar
Buffet standard



Includes:
Wooden frame 2u. GN 1/1 20 mm roll-top lid

Incluye:
Marco madera 2 u. cubeta GN 1/1 20 mm cúpula roll-top

Inclus:
Cadre en bois 2 u. bacs GN 1/1 20 mm couvercle roll-top

REF	W x D x H cm	
P904120	57 x 37 x 31	1/1

Isothermal mat
Tapete isotérmico
Tapis isotherme



REF	W x D x H cm	
P904400	47 x 26 x 20	1/1

Cooling plate
Placa enfriadora
Plaque réfrigérante



Adjustable to 1/1 GN pan.
Adaptable a cubeta GN 1/1.
Adaptable à bac GN 1/1.

REF	W x D x H cm	
P904500	47,5 x 27,7 x 3	1/5

Triple buffet display
Buffet triple
Buffet triple



Includes:
Wooden frame 3 units 1/3 GN pans 65 mm GN pan 1/1 20 mm roll-top lid.

Incluye:
Marco madera 3 cubetas GN 1/3 65 mm cubeta GN 1/1 20 mm cúpula roll-top.

Inclus:
Cadre en bois 3 bacs GN 1/3 65 mm bac GN 1/1 20 mm couvercle roll-top.

REF	W x D x H cm	
P904113	57 x 37 x 31	1/1

Cheese buffet display
Buffet quesos
Buffet fromage



Includes:
Wooden frame wooden cutting board GN pan 1/1 20 mm roll-top lid.

Incluye:
Marco madera bandeja corte madera cubeta GN 1/1 20 mm cúpula roll-top.

Inclus:
Cadre en bois planque à découper en bois bac GN 1/1 20 mm couvercle roll-top.

REF	W x D x H cm	
P904140	57 x 37 x 31	1/1

Melamine slate buffet displayer
Buffet pizarra melamina
Mélamine buffet ardoise



Includes:
Wooden frame melamine slate board 1/1 GN container 20 mm

Incluye:
Marco madera tabla pizarra melamina cubeta GN 1/1 20 mm

Inclus:
Cadre en bois plaque ardoise en mélamine bac GN 1/1 20 mm

REF	W x D x H cm	
P904160	57 x 37 x 14,5	1/1

Bread buffet display
Buffet pan
Buffet pain



Includes:
Wooden frame bread cutting board 1/1 GN container 20 mm

Incluye:
Marco madera cortador pan madera cubeta GN 1/1 20 mm

Inclus:
Cadre en bois plaque à découper pain en bois bac GN 1/1 20 mm

REF	W x D x H cm	
P904145	57 x 37 x 14,5	1/1

Wooden frame
Marco madera
Cadre en bois



P904.200

REF	W x D x H cm	
P904200	57 x 37 x 14,5	1/1

Wooden bread cutting board
Cortador pan madera
Plaque à découper pain en bois



REF	W x D x H cm	
P904146	52 x 31,5 x 20	1/1

Wooden bread cutting board
Cortador pan madera
Plaque à découper pain en bois



GN 1/1

REF	W x D x H cm	
P904142	53 x 32,5 x 2	1/1

EXCLUSIVE



BUFFET TROLLEY WITH POSSIBLE TRANSFORMATION FROM AN EXPOSITOR TROLLEY TO A PRESENTATION TABLE
CARRO BUFFET CON POSIBILIDAD DE CONVERTIR EL CARRO EXPOSITOR EN MESA DE PRESENTACIÓN
CHARIOT BUFFET AVEC POSSIBILITÉ DE CONVERTIR LE CHARIOT D'EXPOSITION EN UNE TABLE DE PRÉSENTATION



Black buffet trolley for 4 1/1 GN inserts
Carro buffet negro 4 GN 1/1
 Chariot buffet noir pour 4 bacs GN 1/1

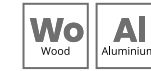

REF	Type / Tipo	
P90490*	4 X GN 1/1	1/1
P90492	Tapa / Cover / Tablette	1/1
P90493	Tapa / Cover / Tablette 1/1	1/1

Outstanding combination of wood and aluminium

Elegante combinación de madera y aluminio
 Combinaison élégante en bois et en aluminium



Wood with special waterproof treatment, easy to clean
Madera con tratamiento hidrófugo especial, de fácil limpieza
 Bois avec un traitement hydrofuge spécial, facile à nettoyer

Reinforcement bar
Barra refuerzo nivel inferior
 Barre de renforcement

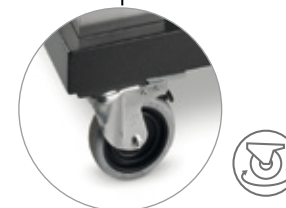

Soundproof and revolving castors
 Ø 125 mm, with brakes
Ruedas giratorias e insonoras de Ø 125 mm, con freno
 Roulettes insonores et pivotantes de Ø 125 mm, avec freins

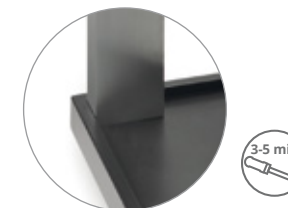

Delivered flatpacked between 3 to 5 minutes assembly
Se suministran desmontados entre 3 a 5 minutos de montaje
 Livrés démontés entre 3 et 5 minutes de montage



Suitable for gastronorm sizes
Adaptado a medidas gastronorm
 Adapté aux mesures gastronorme

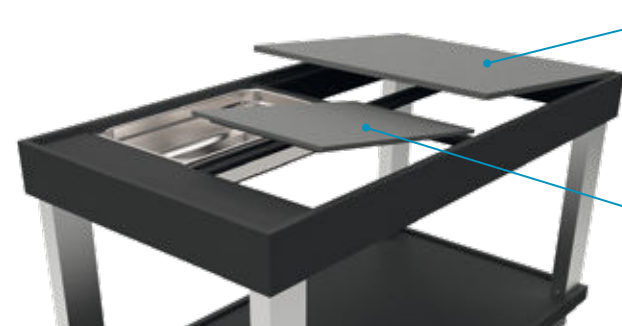

***Two cover are included on the price**
**Dos tapas incluidas en precio*
 *Deux tablettes comprises dans le prix
P90492

Cover for 1/1 GN insert not included on the price
Tapa individual encaje GN 1/1 no incluida en precio
 Tablette de bac GN 1/1 non comprise dans le prix
P90493

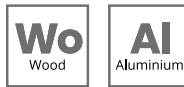

Wooden-aluminium trolley 2 shelves
Carro madera-aluminio 2 estanterías
 Chariot en bois-aluminium 2 plateaux

Waterproof treatment
Tratamiento hidrófugo
 Traitement hydrofuge



REF	Colour	
P80220	Negro / Black / Noir	1/1

Wooden gueridon trolley
Gueridón o carro auxiliar madera
 Chariot guéridon en bois

Waterproof treatment
Tratamiento hidrófugo
 Traitement hydrofuge

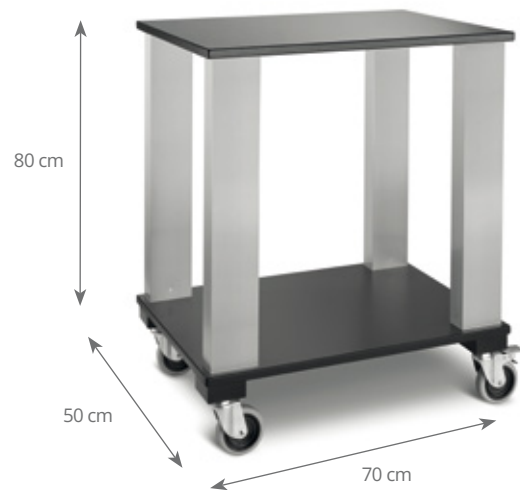

REF	Colour	
P80219	Negro / Black / Noir	1/1

Oak melamine gueridon trolley
Carro guerdón melamina roble
 Chariot guéridon mélamine roure

EXCLUSIVE



REF	
P80216	1/1

Cutlery dispenser trolley
Carro porta-cubiertos
 Chariot porte couverts



EXCLUSIVE



P908132



P90813



Trays, dishes, GN containers and cutlery dispenser not included
No incluye porta-cubiertos, cubetas GN, platos ni bandejas
 Ramasse-couverts, bacs GN, assiettes, et plateaux pas compris

REF	
P908132	1/1
P90813	1/1

Cutlery bin
Porta-cubiertos
 Ramasse-couverts

4 x 1/3 GN
H max. 6,5 cm

EXCLUSIVE



P90814



P908142



GN containers not included
No incluye cubetas GN
 Bacs GN non inclus

REF	W x D x H mm	
P908142	710 x 335 x 155	1/1
P90814	710 x 335 x 155	1/1

14.6 Chafers & dispensers

Chafings y dispensadores / Chafers et distributeurs



- High-quality finish, large glass window and stainless steel in a shiny polished finish.
- Removable lid for easy cleaning.
- Anti-noise plastic stopper to close the lid silently.
- Hydraulic hinge.
- Diffuser base for optimal heat distribution and suitable for induction.
- Suitable for electric components P950000, 46110, and induction plate P157954.
- Acabados de alta calidad, amplia ventana de cristal y acero inoxidable en acabado pulido brillante.
- Tapa extraíble para fácil limpieza.
- Tapa de plástico antiruido para cerrar la tapa silenciosamente.
- Bisagra hidráulica.
- Fondo difusor para una óptima distribución del calor y apto para inducción.
- Compatible con los elementos eléctricos P950000 y 46110 y la placa de inducción P157954.
- Finissage de haute qualité, grande fenêtre en verre et acier inoxydable finissage brillant.
- Couvercle amovible pour un nettoyage facile.
- Butée plastique anti-bruit pour fermer le couvercle en silence.
- Charnière hydraulique.
- Fond diffuseur pour une répartition optimale de la chaleur et adapté à l'induction.
- Compatible avec les éléments électriques P950000, 46110 et la plaque à induction P157954.

Induction warmer for chafing dish

Inducción mantenedora para chafing dish

Plaque induction maintien temp. pour chafing dish



Suitable for
Compatible con
Compatible avec:
P390004, P390005, P390006

Power control
Con control de potencia
Contrôle de puissance

REF	Ø cm	V	W	Hz	Icon	Icon
P157954	24	220-240	1000	50/60	EU	1/1

See products on

Ver productos en / Voir produits en page

P. 495

Electric heating unit for chafing dish

Elemento eléctrico para chafing dish

Corps de chauffe pour chafing dish



Chafers & dispensers 14.6

Chafings y dispensadores / Chafers et distributeurs



Round glass-top chafing dish

Chafing dish redondo con tapa de cristal

Chafing rond couvercle en verre



induction



Stainless steel pan included

Cubeta de acero inoxidable incluida

Bac acier inoxydable inclus

REF	W x D x H cm	L	Icon
P390001	46 x 56 x 16	6	1/1

Round stainless steel pan

Cubeta redonda en acero inoxidable

Bac rond en acier inoxydable



Suitable for
Combinable con
Adaptable pour
P390001



REF	Ø cm	H cm	Icon
P390007	38,5	6,5	1/10

Round chafing stand

Stand chafing dish redondo

Support chafing rond



Suitable for
Combinable con
Adaptable pour
P390001



Stackable
Apilable
Empilable

1 burner holder included

Contenedor para combustible incluido
Porte-brûleur inclus

Strong and robust stainless steel structure.

Resistente y robusta estructura en acero inoxidable.
Structure en acier inoxydable résistante et robuste.

REF	W x D x H cm	Icon
P390004	44,5 x 52 x 23,5	1/1

Round porcelain pan

Cubeta redonda de porcelana

Bac rond en porcelaine



Suitable for
Combinable con
Adaptable pour
P390001



REF	Ø cm	H cm	Icon
P390010	38,5	6,5	1/1

14.6 Chafers & dispensers

Chafings y dispensadores / Chafers et distributeurs



Square glass-top chafing dish
Chafing dish cuadrado con tapa de cristal
Chafer carré couvercle en verre



Stainless steel pan included
Cubeta de acero inoxidable incluida
Bac acier inoxydable inclus

REF	W x D x H cm	L	
P390002	41 x 50 x 16	5,5	1/1

Square chafing stand
Stand chafing dish cuadrado
Support chafer carré



Suitable for
Combinable con
Adaptable pour
P390002

Stackable
Apilable
Empilable

1 burner holder included
Contenedor para combustible incluido
Porte-brûleur inclus

Strong and robust stainless steel structure.
Resistente y robusta estructura en acero inoxidable.
Structure en acier inoxydable résistante et robuste.

REF	W x D x H cm	
P390005	48 x 37,5 x 23,5	1/1



Rectangular glass-top chafing dish
Chafing dish rectangular con tapa de cristal
Chafer rectangulaire couvercle en verre

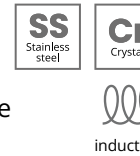

1/1



Stainless steel pan included
Cubeta de acero inoxidable incluida
Bac acier inoxydable inclus

REF	W x D x H cm	L	
P390003	58 x 50 x 16	9	1/1

Rectangular chafing stand
Stand chafing dish rectangular
Support chafer rectangulaire



Suitable for
Combinable con
Adaptable pour
P390003

Stackable
Apilable
Empilable

2 burner holder included
Contenedor para combustible incluido
Porte-brûleur inclus

Strong and robust stainless steel structure.
Resistente y robusta estructura en acero inoxidable.
Structure en acier inoxydable résistante et robuste.

REF	W x D x H cm	
P390006	66 x 37,5 x 23,5	1/1

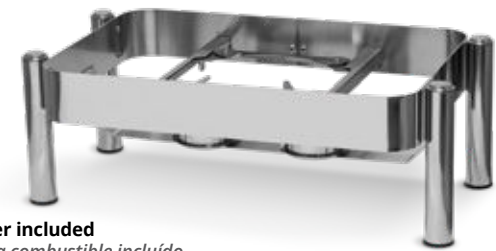

Square stainless steel pan
Cubeta cuadrada en acero inoxidable
Bac carré en acier inoxydable



Suitable for
Combinable con
Adaptable pour
P390002

REF	W x D x H cm	
P390008	35,3 x 32,5 x 6,5	1/10

Square porcelain pan
Cubeta cuadrada de porcelana
Bac carré en porcelaine



Suitable for
Combinable con
Adaptable pour
P390002

REF	W x D x H cm	
P390011	35,5 x 33 x 6,5	1/1

Rectangular stainless steel pan
Cubeta rectangular en acero inoxidable
Bac rectangulaire en acier inoxydable



Suitable for
Combinable con
Adaptable pour
P390003

REF	W x D x H cm	
P390009	53,5 x 32,5 x 6,5	1/10

Rectangular porcelain pan
Cubeta rectangular de porcelana
Bac rectangulaire en porcelaine



Suitable for
Combinable con
Adaptable pour
P390003

REF	W x D x H cm	
P390012	53,5 x 32,5 x 6,5	1/1

Chafers & dispensers 14.6

Chafings y dispensadores / Chafers et distributeurs



Rectangular glass-top chafing dish
Chafing dish rectangular con tapa de cristal
Chafer rectangulaire couvercle en verre

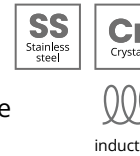

1/1



Stainless steel pan included
Cubeta de acero inoxidable incluida
Bac acier inoxydable inclus

REF	W x D x H cm	L	
P390003	58 x 50 x 16	9	1/1

Rectangular chafing stand
Stand chafing dish rectangular
Support chafer rectangulaire



Suitable for
Combinable con
Adaptable pour
P390003

Stackable
Apilable
Empilable

2 burner holder included
Contenedor para combustible incluido
Porte-brûleur inclus

Strong and robust stainless steel structure.
Resistente y robusta estructura en acero inoxidable.
Structure en acier inoxydable résistante et robuste.

REF	W x D x H cm	
P390006	66 x 37,5 x 23,5	1/1

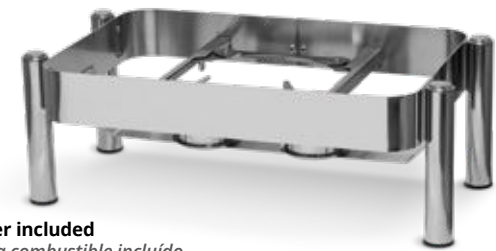

Square stainless steel pan
Cubeta cuadrada en acero inoxidable
Bac carré en acier inoxydable



Suitable for
Combinable con
Adaptable pour
P390002

REF	W x D x H cm	
P390008	35,3 x 32,5 x 6,5	1/10

Square porcelain pan
Cubeta cuadrada de porcelana
Bac carré en porcelaine



Suitable for
Combinable con
Adaptable pour
P390002

REF	W x D x H cm	
P390011	35,5 x 33 x 6,5	1/1

Rectangular stainless steel pan
Cubeta rectangular en acero inoxidable
Bac rectangulaire en acier inoxydable



Suitable for
Combinable con
Adaptable pour
P390003

REF	W x D x H cm	
P390009	53,5 x 32,5 x 6,5	1/10

Rectangular porcelain pan
Cubeta rectangular de porcelana
Bac rectangulaire en porcelaine



Suitable for
Combinable con
Adaptable pour
P390003

REF	W x D x H cm	
P390012	53,5 x 32,5 x 6,5	1/1

14.6 Chafers & dispensers

Chafings y dispensadores / Chafers et distributeurs



Square chafing dish
Chafing dish cuadrado
Chauffe-plat carré



REF	W x D x H cm	L	
46132	39,2 x 41,3 x 20,3	5,8	1/1

Glass top S/S chafer with S/S trim
Chafing dish cuadrado con tapa cristal
Chafer inox à couvercle en verre



REF	W x D x H cm	L	
46134	39,2 x 41,3 x 17,6	5,8	1/1

Glass top S/S chafer with S/S trim
Chafing dish redondo con tapa cristal
Chafer inox à couvercle en verre



REF	Ø cm	H cm	L	
46125	39,4	8	5,8	1/1

Food pan
Fuente interior redonda
Bac à aliments



REF	cm	L	
46131	39,4 x 7	5,6	1/1
46861	39,4 x 7	3,8	1/1

Food pan
Fuente interior cuadrada
Bac à aliments



REF	W x D x H cm	L	
46137	39,2 x 7,1 x 39,2	6,3	1/1

Chafers & dispensers 14.6

Chafings y dispensadores / Chafers et distributeurs



Rectangular chafing dish roll top lid
Chafing dish rectangular con tapa roll top
Chafing dish rectangulaire avec couvercle roll top



Stand, water pan, insert, lid and St/Steel handles. With 2 burners.

Soporte, recipiente, cubeta, tapa y asas de chapa en acero inox. Con 2 quemadores.

Support, récipient, bac, couvercle et poignées en acier inox. Avec 2 brûleurs.

REF	W x D x H cm	L	
P387500	74 x 45 x 41	9	1/1

Round chafing dish roll top lid
Chafing dish redondo tapa roll top
Chafing dish rond avec couvercle roll top

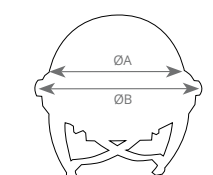

Max. opening: 180°.
Apertura máxima: 180°.
Ouverture maximale: 180°.

REF	ØA cm	ØB cm	H cm	L	
P897500	35	51,5	48,5	6	1/1

14.6 Chafers & dispensers

Chafings y dispensadores / Chafers et distributeurs



Chafing dish with roll top lid
Chafing dish con tapa roll top
Chafing dish avec couvercle "roll top"



Stand, water pan, insert, lid and St/Steel handles. With 2 burners. Soporte, recipiente, cubeta, tapa y asas de chapa en acero inox. Con 2 quemadores. Support, récipient, bac, couvercle et poignées en acier inox. Avec 2 brûleurs.

REF	W x D x H cm	L	Shopping icon
P387065	65 x 38 x 39	9,5	1/1

Chafing dish with lid
Chafing dish con tapa
Chafing dish avec couvercle



Stand, water pan, insert, lid and St/Steel handles. With 2 burners. Soporte, recipiente, cubeta, tapa y asas de chapa en acero inox. Con 2 quemadores. Support, récipient, bac, couvercle et poignées en acier inox. Avec 2 brûleurs.

REF	W x D x H cm	L	Shopping icon
P379065	65 x 35 x 34	9,5	1/1

Economical chafing dish with lid
Chafing dish económico con tapa
Chafing dish économique avec couvercle



Stand, water pan, insert, lid and St/Steel handles. With 2 burners. Soporte, recipiente, cubeta, tapa y asas de chapa en acero inox. Con 2 quemadores. Support, récipient, bac, couvercle et poignées en acier inox. Avec 2 brûleurs.

REF	W x D x H cm	L	Shopping icon
P379500	65 x 35 x 32	9	1/1

Cooling plate
Placa enfriadora
Plaque réfrigérante



For an easy and hygienic presentation of cold food. Simple place in the freezer. Minimum 4 hour under -4°C. Tolerance under 23°C: 5-6h.

Para una presentación fácil e higiénica de alimentos fríos en los buffets. En el congelador: Mínimo 4h por debajo de los -4 °C. Aguanta 5-6h con temperaturas por debajo de los 23 °C.

Pour une présentation hygienique et facile des aliments froids sur les buffets. Au congélateur. Minimum 4h à des températures inférieures à -4 °C. Résistance à des températures inférieures à 23 °C: 5-6h.

REF	Type / Tipo	cm	Shopping icon
P903001	1/1	53 x 32,5	1/1
P903002	1/2	32,5 x 26,5	1/1

Bain maries
Baño maría
Bain-marie



REF	Ø cm	H cm	L	Shopping icon
78710	10,5	14,5	1,20	1/6
78720	12,5	17,0	1,90	1/6
78725	15,5	10,0	1,90	1/6
78730	15,5	18,5	3,30	1/6
78740	16,5	19,5	4,00	1/6
78760	18,5	22,0	5,70	1/6

Chafers & dispensers 14.6

Chafings y dispensadores / Chafers et distributeurs

Electric heating unit for chafing dish
Elemento eléctrico para chafing dish
Corps de chauffe pour chafing dish



Suitable for stands / Compatible con stands / Compatible avec stands : P387500, P897500, P387065, P379065, P379500, P390004, P390005, P390006

REF	W	Shopping icon
P950000	240	1/1

Hot tray warmer
Calentador de platos o bandejas
Réchaud



Burner holder for chafing dish
Contenedor para combustible de chafing dish
Porte-brûleur pour chafing dish



Adaptable. REF: P379, P387

REF	Shopping icon
P372200	1/1

Chafing dish fuel
Fuel para chafing dish
Fuel pour chafing dish



REF	cm	g	Lenght / Duración	Shopping icon
P387100	6,5 x 5,5	160	3 h	1/75
P387200	8,3 x 6,0	280	6 h	1/60

Universal electric chaffer heater
Elemento eléctrico universal para chafing dish
Résistance électrique pour chafers



Sized to fit standard fuel opening. Dimensiones compatibles con el orificio para combustible estándar. Dimensions compatibles avec l'orifice pour combustible standard.

REF	For / Para	V	W	A	Ench. Plug	Shopping icon
46110	EU	230	120/230	1.0	EU	1/1
46115	UK	230	120/230	1.0	UK	1/1

REF	Burners Quemadores Brûleurs	W x D x H cm	Shopping icon
P962002	2	37 x 17,5 x 7	1/1
P962003	3	43 x 17,5 x 7	1/1

St/Steel with aluminium cover plate. Inox con placa base de aluminio. Inox avec plaque couvercle en aluminium. **2 or 3 burners.** 2 ó 3 quemadores. 2 ou 3 brûleurs.

Chafing dish fuel barrel
Fuel para chafing dish
Bidón fuel chafing dish



No soot. No smell
Sin hollín. Sin olor
Pas de suie. Inodore

REF	L	Kg	Shopping icon
P685004	5	5	1/1

Thanks to its special formula no storage or transport restriction are involved. Resealable. Non spill - Non drip. Non flammable. Non combustible. Non toxic fuel. Easy open & close. Container does not become hot to touch. Does not evaporate if left uncapped.

Gracias a su fórmula especial no hay ninguna restricción especial por almacenaje o transporte. No gotea ni se derrama. No se evapora si se deja abierto. Puede guardarse si no se consume todo. No inflamable. No tóxico. Fácil de abrir y cerrar. La lata no se calienta. Fácil de encender una vez apagada.

Grâce à sa formule spéciale il n'y pas de restriction pour le stockage et le transport. Hermétique. Non inflammable. Non combustible. Non toxique. Facile à ouvrir et fermer. On peut le garder si on ne le consomme pas tout. Facile à allumer une fois éteint.

14.6 Chafers & dispensers

Chafings y dispensadores / Chafers et distributeurs

Cold beverage server
 Dispensador de bebidas frías
 Distributeur boisson froide



REF	W x D x H cm	L	
46285	20,3 x 28 x 53,3	7,6	1/1

Somerville milk dispenser
 Dispensador de leche-Somerville
 Distributeur de lait Somerville



REF	W x D x H cm	L	
4635110	20,3 x 32,7 x 41,4	4,8	1/1

Cereal dispenser
 Dispensador de cereales
 Distributeur à céréales



REF	W x D x H cm	L	
P899400	20 x 24 x 64	3,5	1/1

Double cereal dispenser
 Dispensador de cereales doble
 Distributeur à céréales double



REF	W x D x H cm	L (x2)	
P899500	33,5 x 24 x 64	3,5	1/1

Juice dispenser St/Steel
 Dispensador de zumos - acero inox
 Distributeur à jus - acier inox



REF	W x D x H cm	L	
P899200	26 x 35 x 57	8	1/1

St/Steel milk dispenser
 Dispensador de leche - acero inox
 Distributeur à lait - acier inox



REF	W x D x H cm	L	
P899300	26 x 35 x 57	8	1/1

Cereal dispenser
 Dispensador de cereales
 Distributeur à céréales



REF	W x D x H cm	L	
P899600	21 x 17 x 61,5	3,5	1/1

Double Cereal Dispenser
 Dispensador de cereales doble
 Distributeur à céréales double



REF	W x D x H cm	L (x2)	
4635210	31 x 22 x 60	3,8	1/1

14.7 Protection and covers

Protección y tapas / Protection et couvercles

Mobile and ajustable breath guards
Protección Anti-aliento regulable
 Pare-haleine ajustable



Adjustable in tilt and height to adapt to different spaces. Protect exposed foods without losing visibility.

Ajustable en inclinación y altura para adaptarse a diferentes espacios. Protege los alimentos expuestos sin perder visibilidad.

Hauteur et inclinaison réglables pour s'adapter à tous les espaces des buffets. Protège et laisse visible les aliments exposés.

REF	W x D x H cm	Shopping icon
P19120	120 x 45 x 38	1/1

Dome cover
Tapa campana
 Couvercle cloche



REF	Ø cm	H cm	Shopping icon
P590008	21	17,5	1/1
P590009	26	20,0	1/1
P590010	31	23,5	1/1

Display tray
Bandeja presentación
 Plateau présentation

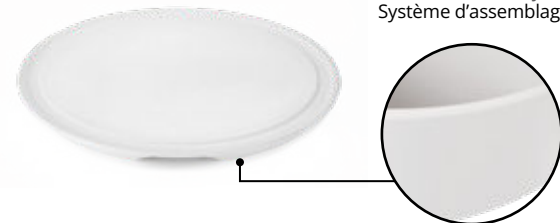

Fitting system
Sistema de encaje
 Système d'assemblage

REF	Ø cm	H cm	Shopping icon
P22361	22,7	1,5	1/12
P22362	27,8	1,5	1/6
P22363	32,7	1,5	1/6

Stand
Stan
 Base



Suitable for
Combinable con
 Adaptable pour
 P22361 / P22362 / P22363

REF	Ø cm	H cm	Shopping icon
P22366	16,5	10	1/6
P22367	16,5	18	1/6

Clear round lid for presentation
Tapa redonda transparente presentación
 Couvercle rond transparent pour présentation



REF	Ø cm	H cm	Suitable for	Shopping icon
P598700	22	13,5	P22127 / P22124	1/1
P598800	27	16,5	P22128 / P22125	1/1

Protection and covers 14.7

Protección y tapas / Protection et couvercles

Round display cabinet
Vitrina redonda
 Vitrine ronde



REF	Ø cm	H cm	Base útil	Shopping icon
P590005	38	22	31,5	1/1
P590006	46	26	37,5	1/1

Rectangular display cabinet
Vitrina rectangular
 Vitrine rectangulaire



REF	W x D x H cm	Base útil	Shopping icon
P590001	40 x 24,5 x 15,5	34 x 19	1/1
P590002	50,5 x 30,5 x 18	44 x 24,5	1/1

Double display cabinet
Vitrina doble
 Vitrine double



REF	W x D x H cm	Base útil	Shopping icon
P590003	40 x 24,5 x 32	2 x (34 x 19)	1/1
P590004	50,5 x 30,5 x 40	2 x (44 x 24,5)	1/1

Clear GN lids for presentation
Tapas GN transparentes presentación
 Couvercles GN transparents de présentation



REF	Mod	H cm	Shopping icon
P590110	1/1	10	1/6
P590120	1/2	10	1/6
P590130	1/3	10	1/6
P590240	2/4	10	1/12

Roll-top lid
Tapa roll-top
 Couvercle roll-top



REF	Mod	W x D x H cm	Shopping icon
P904300	1/1	57 x 32,5 x 17,5	1/1

GN prectangular lid
Tapa rectangular GN
 Couvercle rectangulaire GN



REF	Mod	W x D x H cm	Shopping icon
P834000	1/1	53 x 32,5 x 10	1/6

14.8 Bowls & serving trays

Bols & bandejas de servicio / Bols & plateaux

18/10
Stainless
steel

Double wall insulated serving bowls that allows keeping the food temperature, whether cold or hot.

Construcción aislante de pared doble que permite conservar la temperatura de los alimentos, ya sean fríos o calientes.

Construction d'isolation à double paroi qui permet de maintenir la température de la nourriture, froide ou chaude.

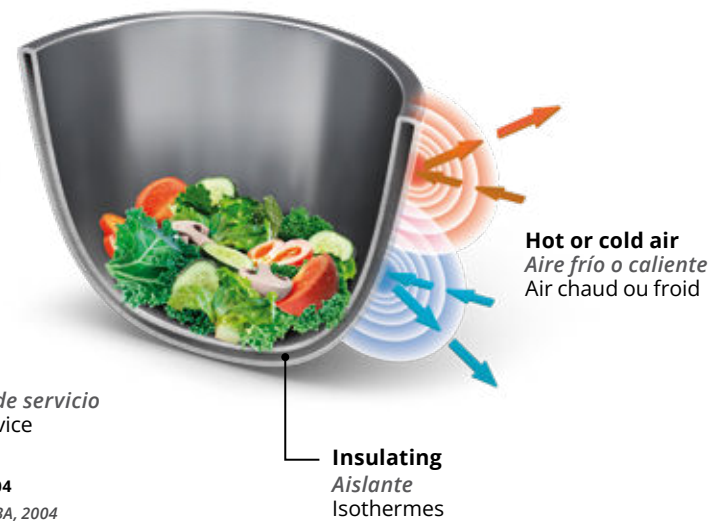

Will not TRANSPIRE. Requires no preheating or chilling

No transpiran. No es necesario precalentar o enfriar
Pas de condensation sur les parois. N'exige aucun préchauffage ou refroidissement

Insulating walls that keep food at service temperature

Paredes aislantes que mantienen los alimentos a la temperatura de servicio
Construction isolant qui garde les aliments à la température de service

COLD RETENTION: Double wall insulated bowls TEST PROTOCOL, 2004

RETENCIÓN DEL FRÍO: Bols aislantes de doble pared PROTOCOLO DE PRUEBA, 2004

RÉTENTION DU FROIDE: Construction d'isolation à double paroi PROTOCOLE D'ESSAI, 2004

Angled beehive bowls

Bol inclinado doble pared
Bols nid d'abeilles à paroi inclinée

NSF



REF	Ø cm	H cm	L	🛒/📦
46584	18,8	13,9	0,95	1/6
46585	24,0	17,3	1,7	1/6
46586	30,0	20,9	3,5	1/2
46582	35,0	23,9	4,7	1/2

Double-wall square beehive serving bowls

Bol estriado cuadrado doble pared
Bol lis carré double paroi

NSF



REF	W x D x H cm	L	🛒/📦
47619	13,9 x 13,9 x 7	0,7	1/6
47632	18,5 x 18,5 x 8,9	1,7	1/12
47634	21,8 x 21,8 x 10,8	3,0	1/6
47635	24,4 x 24,4 x 13,1	4,9	1/4
47637	29,9 x 29,9 x 15	7,8	1/3

Beehive style double-wall serving bowls

Bol estriado redondo doble pared
Bol à bande rond double paroi

NSF

Mirror finished
Acero inoxidable brillante
Polissage brillant



REF	Ø cm	H cm	L	🛒/📦
46587	14,4	7,6	0,7	1/6
46590	18,4	10,3	1,6	1/6
46591	24,1	12,9	3,2	1/6
46592	30,0	16,5	6,6	1/3
46599	35,0	17,5	9,6	1/2

Beehive style double-wall serving bowls

Bol redondo doble pared con aro brillante
Bol bande brillant rond double paroi

NSF

Body mat finished.
Rim mirror finished.
Cuerpo pulido satinado.
Borde superior pulido brillante.
Finition corps satinée.
Finition bande brillante.



REF	Ø cm	H cm	L	🛒/📦
46665	14,4	7,6	0,7	1/6
46666	18,4	10,3	1,6	1/6
46667	24,1	12,9	3,2	1/6

Bowls & serving trays 14.8

Bols & bandejas de servicio / Bols & plateaux

Satin-finished rim and mirror-finished interior creates a visual contrast that accentuates the food product

Borde con acabado satinado e interior brillante, creando una elegante contraste visual

Le rebord satiné et l'intérieur ultra-brillant crée un contraste visuel qui met en valeur les plats

Rectangular Stainless Steel serving trays
Bandeja servicio rectangular acero inoxidable
Plateau service rectangulaire

18/10
Stainless
steel



REF	cm	🛒/📦
82093	30,5 x 22,9	1/3
82094	45,7 x 25,4	1/3
82095	53,3 x 30,5	1/3

Economical oval serving dish with rolled edge

Fuente oval borde vuelto económica
Plat ovale à bords ronds économique

18/10
Stainless
steel

Mirror finished
Pulido brillante
Polissage brillant



REF	cm	🛒/📦
P317425	25 x 17,5	1/10
P317430	30 x 21,0	1/10
P317435	35 x 24,0	1/10
P317440	40 x 26,5	1/10
P317445	45 x 29,5	1/10
P317450	50 x 34,0	1/10

Oval serving dish with rolled edge

Fuente oval borde vuelto
Plat ovale à bords ronds

18/10
Stainless
steel

Satin finished
Pulido satinado
Polissage satiné



REF	cm	🛒/📦
P317025	25 x 17,2	1/50
P317030	30 x 20,2	1/50
P317035	35 x 23,3	1/25
P317040	40 x 26,7	1/25
P317045	45 x 29,2	1/25
P317050	50 x 31,2	1/25

St/Steel soup tureen with stand

Sopera inox con base
Soupière inox avec pied

SS
Stainless
steel



Mirror finished
Pulido brillante
Polissage brillant

REF	Ø cm	L	🛒/📦
P907024	24	2,50	1/3
P907026	26	3,50	1/3

Acrylic Squared salad bowl

Ensaladera acrílica cuadrada
Saladier carré acrylique

Ac
Acrylic



REF	W x D x H cm	🛒/📦
P928000	28,5 x 28,5 x 12,4	1/12
P928001	14,7 x 14,7 x 7	1/48

Serving tools 14.9

Utensilios de servicio / Ustensiles de service buffet

SS
Stainless
steel

CLASSIC LINE



One piece ladle
Cacillo monobloc
Louche monobloc



REF	Ø cm	L cm	L	Shopping icon	Box icon
P361000	9	30	0,10	1/12	

One piece skimmer
Espumadera monobloc
Écumoire monobloc



REF	Ø cm	L cm	L	Shopping icon	Box icon
P362000	11	33,5	10,40	1/12	

One piece turner
Espátula monobloc
Spatule monobloc



REF	L cm	Shopping icon	Box icon
P363000	32	1/12	

One piece serving spoon
Cuchara de servicio monobloc
Cuillère de service monobloc



REF	L cm	Shopping icon	Box icon
P364000	31	1/12	

One piece fork
Tenedor monobloc
Fourchette monobloc



REF	L cm	Shopping icon	Box icon
P365000	32	1/12	

One piece sauce ladle
Cacillo salsas monobloc
Cuillère à sauces monobloc



REF	Ø cm	L cm	L	Shopping icon	Box icon
P366000	7	28	0,10	1/12	

One piece salad spoon
Cuchara ensalada monobloc
Cuillère à salade monobloc



REF	L cm	Shopping icon	Box icon
P367000	30	1/12	

Carving knife
Cuchillo cocina
Couteau à pâtisserie



REF	L cm	Shopping icon	Box icon
P368000	28,5	1/24	

Cake server
Pala pasteles
Pelle à gâteau



REF	L cm	Shopping icon	Box icon
P369000	22	1/12	

14.9 Serving tools

Utensilios de servicio / Ustensiles de service buffet



ERGO LINE



Mirror polishing.
Pulido brillante.
Polissage brillant.



Serving tools 14.9

Utensilios de servicio / Ustensiles de service buffet

COMET LINE



Mat satiny finished.
Pulido satinado mate.
Poli satiné mat.

One piece ladle
Cacillo monobloc
Louche monobloc



REF	Ø cm	L cm	L	
P361100	9,5	32	0,15	1/6

One piece skimmer
Espumadera monobloc
Écumoire monobloc



REF	Ø cm	L cm	L	
P362100	11	35	7,15	1/6

One piece ladle. 18% cr. St/Steel
Cacillo monobloc. Acero inox 18% cr.
Louche monobloc. inox 18% cr.



REF	Ø cm	L cm	L	
P341000	8,5	28	0,10	1/10

One piece skimmer. 18% cr. St/Steel
Espumadera monobloc. inox 18% cr.
Écumoire monobloc. inox 18% cr.



REF	Ø cm	L cm	
P342000	11	33	1/12

One piece turner
Espátula monobloc
Spatule monobloc



REF	L cm	
P363100	37	1/6

One piece serving spoon
Cuchara de servicio monobloc
Cuillère de service monobloc



REF	L cm	
P364100	34,5	1/6

One piece turner. 18% cr. St/Steel
Espátula monobloc. inox 18% cr.
Spatule monobloc. inox 18% cr.



REF	L cm	
P343000	33	1/10

One piece spoon. 18% cr. St/Steel
Cuchara monobloc. inox 18% cr.
Cuillère monobloc. inox 18% cr.



REF	L cm	
P345000	34	1/10

Spaghetti server
Cuchara para spaghetti
Cuillère à spaghetti



REF	L cm	
P367100	35	1/6

Cake server
Pala pasteles
Pelle à gâteau



REF	L cm	
P369100	31	1/6

Steak knife black plastic handle
Cuchillo chuletero, mango plástico negro
Couteau Steak manche noir plastique



REF	Blade / Hoja / Lame L cm	Total L cm	
48144	12,4	25,1	1/12

Price / Precio / Prix: Pack 12 u

14.9 Serving tools

Utensilios de servicio / Ustensiles de service buffet



Ladle with one spout
Cacillo con un pico lateral
Louche avec bec latéral

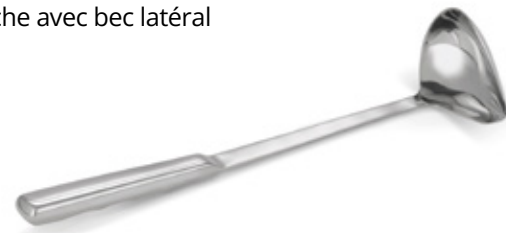

REF	L cm	Shopping icon
46905	28,71	1/12

Ladle with one spout
Cacillo con un pico lateral
Louche avec bec latéral



REF	L cm	ml	Shopping icon
46907	32	59,15	1/12

Ladle
Cacillo
Louche



REF	L cm	Shopping icon
46909	32	1/12

Pastry server
Servidor de pasteles
Pelle de service



REF	L cm	Shopping icon
46936	28	1/12

Serving spoon
Cuchara de servicio
Cuillère de service



REF	L cm	Shopping icon
46952	29,5	1/12

Slotted serving spoon
Cuchara perforada para servir
Cuillère à fente de service



REF	L cm	Shopping icon
46960	30,5	1/12

Spoon
Cuchara
Cullière



REF	L cm	Shopping icon
64403	33,60	1/12
64404	33,60	1/12
64406	39,37	1/12
64407	39,37	1/12

Serving tools 14.9

Utensilios de servicio / Ustensiles de service buffet



dishwasher

- 40 °C

+210 °C

Ladle
Cacillo
Louche



REF	L cm	Lts	Shopping icon
P33621	35	0,08	1/12

Serving spoon
Cuchara de servicio
Cuillère de service



REF	L cm	Shopping icon
P33622	35	1/12

Slotted spoon
Cuchara perforada
Cuillère à fente



REF	L cm	Shopping icon
P33623	35	1/12

Turner
Espátula
Patule



REF	L cm	Shopping icon
P33624	35	1/12

Spaghetti server
Cuchara para spaghetti
Cuillère à spaghetti



REF	L cm	Shopping icon
P33625	35	1/12

14.9 Serving tools

Utensilios de servicio / Ustensiles de service buffet



Serving spoon
Cuchara de servicio
Cuillère de service



REF	L cm	Shopping icon
P33801	30,5	1/16

Turner
Espátula
Spatule



REF	L cm	Shopping icon
P33803	30,5	1/10

Serving tong
Pinza de servicio
Pince de service



REF	L cm	Shopping icon
P33806	28	1/10

Bread spoon
Pinza de pan
Pince à pain



REF	L cm	Shopping icon
P33807	25,5	1/8

See products on / Ver productos en / Voir produits en page

P. 449

Wooden bowl
Bol de madera
Bol en bois



Serving tools 14.9

Utensilios de servicio / Ustensiles de service buffet



Coloured BPA Free utility tong
Pinza buffet BPA Free color
Pince buffet SANS BPA en couleurs



REF	L cm	Clear Transp.	○	●	●	Shopping icon
P358	23	0	1	2	7	1/12

REF 358 + L + COLOR

Serving tong
Pinza servicio
Pince de service



REF	L cm	Shopping icon
46926	21	1/12

Buffet tong
Pinza buffet
Pince à buffet



REF	L cm	Shopping icon
46938	30,5	1/6

Spaghetti tong
Pinza espagueti
Pince à spaghettis



REF	L cm	Shopping icon
46988	23,0	1/12
46989	29,2	1/12

BUFFET & ACCESSORIES
BUFFET / ACCESORIOS
BUFFET ET ACCESSOIRES

BUFFET & ACCESSORIES
BUFFET / ACCESORIOS
BUFFET ET ACCESSOIRES

14.9 Serving tools

Utensilios de servicio / Ustensiles de service buffet



Serving tong
Pinza de servicio
Pince de service



REF	L cm	
P359000	24	1/12

Salad tong
Pinza ensalada
Pince à salade



REF	L cm	
P353000	26,5	1/12

Bread tong
Pinza pan
Pince à pain



REF	L cm	
46928	23,5	1/12

Bread tong
Pinza pan
Pince à pain



REF	L cm	
P606000	25	1/12

Pasta tong
Pinza pasta
Pince à pâtes



REF	L cm	
P605000	24	1/12

Spaghetti tong
Pinza spaghetti
Pince à spaghetti



REF	L cm	
P351000	19	1/12

Cake tong
Pinza repostería
Pince à gâteau



REF	L cm	
P352000	18	1/12



Tong with ring
Pinza anillas
Tong with ring



REF	L cm	
P617017	17	1/12

Pastry tong
Pinza pastelería
Pince à pâtisserie



REF	L cm	
46929	20	1/24

Butcher's tong
Pinza charcutería
Pince à charcuterie



REF	L cm	
P902000	10,5 x 5	1/12

Serving tools 14.9

Utensilios de servicio / Ustensiles de service buffet

Burger tong
Pinza hamburguesa
Pince à "burger"



REF	L cm	
P618000	24	1/12

Nut cracker
Cascanueces
Casse-noix



REF	L cm	
P615000	16,5	1/12

Aluminium lobster cracker
Pinza para mariscos en aluminio
Casse-pattes en aluminium



REF	L cm	
P389000	14	1/24

14.10 Signs

Señalización / Signalization

Signs 14.10

Señalización / Signalization

Barrier with retractable belt
 Poste con cinta retráctil
 Poteau dérouleur à sangle



SS
Stainless steel

Pintado negro
 Black-painted
 Peint noir

REF	H cm	Kg	Shopping icon
P19117	90	7	1/6

Barrier with retractable belt
 Poste con cinta retráctil
 Poteau dérouleur à sangle



SS
Stainless steel

Mirror Polished.
 Pulido brillante.
 Polissage brillant.

Detachable head.
 Cabezal removible.
 Tête amovible.

REF	Ribbon / Cinta Ruban	H cm	L cm	Kg	Shopping icon
P19114N	●	94	200	9	1/2
P19114A	●	94	200	9	1/2
P19114R	●	94	200	9	1/2

Information sign
 Panel información
 Panneau information

SS
Stainless steel



For barrier
 Para poste
 Pour poteau
 P19117

REF	cm	Shopping icon
P19118	22 x 46	1/10

Spare head
 Recambio cabezal
 Rechange de sangle

SS
Stainless steel



For barrier
 Para poste
 Pour poteau
 P19114

REF	Ribbon / Cinta Ruban	L cm	Shopping icon
P19115N	●	200	1/12
P19115A	●	200	1/12
P19115R	●	200	1/12

Information sign
 Panel información
 Panneau information

SS
Stainless steel



For barrier
 Para poste
 Pour poteau
 P19114

REF	cm	Shopping icon
P19116	21,8 x 32	1/10

St/Steel barrier
 Poste separación acero inoxidable
 Poteau acier inoxydable

SS
Stainless steel



P19100
 Mirror Polished.
 Pulido brillante.
 Polissage brillant.

P19101
 Golden coated.
 Baño dorado.
 Doré.

Belt not included
 Cordon no incluido
 Cordon non inclus

REF	H cm	Kg	Shopping icon
P19100	95	10,5	1/2
P19101	100	10,5	1/2

Belt with chromium-plated ends
 Cordón con ganchos cromados
 Cordon à crochets chromés

Te
Textile

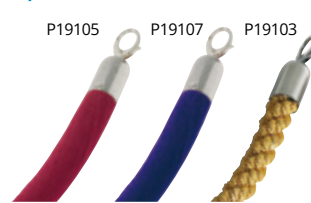

REF	Blet Cord. Ruban	L cm	Shopping icon
P19105	●	150	1/18
P19107	●	150	1/18
P19103	●	150	1/18

Belt with golden ends
 Cordón con ganchos dorados
 Cordon à crochets dorés

Te
Textile

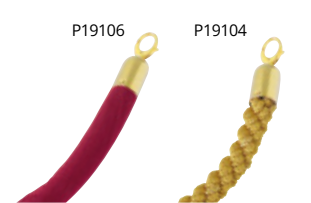

REF	Blet Cord. Ruban	L cm	Shopping icon
P19106	●	150	1/18
P19104	●	150	1/18

Produced from special plastic completely anti-scratch material. Solid wood frame double-lacquered. Rain and sunproof. Writing-surfaces specially designed for using water based chalkmarkers.

Fabricadas con un material plástico especial que no se raya. Marcos de madera resistentes al agua y al sol. Pizarras especialmente diseñadas para el uso de tizas o rotuladores con base de agua. Fabriqués avec un matériel plastique spécial anti-rayures. Cadres en bois massif. Résistants à la pluie et au soleil. Tableaux spécialement conçus pour l'utilisation des craies ou marqueurs avec base à eau.

Caballote - Duo

Wo Wood
 PI Plastic



REF	W cm	H cm	Shopping icon
P21000	75	135	1/1
P21001	55	85	1/1

Caballote - Uno

Wo Wood
 PI Plastic

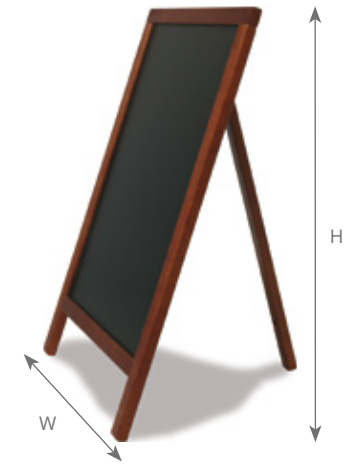

REF	W cm	H cm	Shopping icon
P21003	55	85	1/1

Universal

Wo Wood
 PI Plastic



REF	W cm	H cm	Shopping icon
P21005	50	60	1/1

Lucky

Wo Wood
 PI Plastic

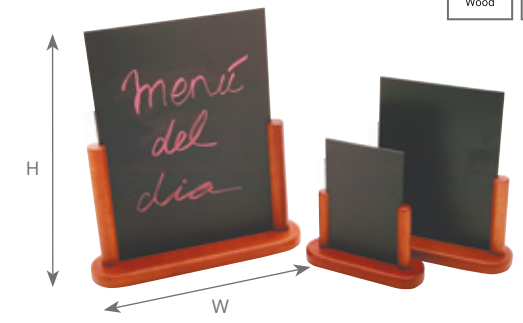

REF	W cm	H cm	Shopping icon
P21015	10	15	1/1
P21016	15	21	1/1
P21017	21	30	1/1

Basic

PI
Plastic

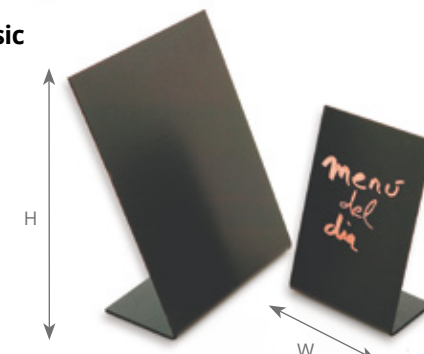

REF	W cm	H cm	Shopping icon
P21027	10	15	1/50
P21028	15	23	1/50

Chalkmarker
 Marcador tiza
 Marqueur

PI
Plastic



Widths 2-6 mm
 Grueso 2-6 mm
 Épaisseur 2-6 mm

REF	Colour / Color / Couleur	Shopping icon
P21020	White / Blanco / Blanc	1/1